

Hf MeffGate T5.9

Fix Interface Specifications (Private information)

28 April 2023

Changes made in the latest revision

Outlined below are the main changes made in the version T5.9 (since the version T5.6 on 30 May 2019):

- Logon message sent by HF SMARTGate. New user field:
 - Current business session date. BusinessSessionDate [21505].
- Registration Instructions and Registration Instructions Response messages:
 - SelfMatchPreventionID field [2362] has been added.
- ExecutionReport and Quote Status Report messages:
 - Information about Latency Protection has been added. StipulationValue [234] when StipulationType [233] = "LATENCY"

Outlined below are the main changes made since the version on 2 September 2019:

- Security Definition message: Text[58] is added

Outlined below are the main changes made since the version on 2 March 2023:

- Adaptation of the document to the new corporate template

Contents

Changes made in the latest revision	2
1 Introduction	7
1.1 Scope of this manual	7
1.2 Private information	8
1.3 Structure of manual	8
1.4 Format of the message definition tables	9
1.5 Related documents	10
2 Implementation decisions.....	11
2.1 Description	11
2.2 Fields ignored.....	11
2.3 Unsupported fields	11
2.4 Length of String type	11
2.5 Maximum length of message.....	11
2.6 Encryption	11
2.7 Identification of the HF MEFFGate FIX protocol.....	11
3 FIX Session.....	12
3.1 Introduction.....	12
3.2 FIX session and communication session.....	12
3.3 Identification of the FIX session.....	12
3.4 Client software and FIX sessions	13
3.5 Message routing from different users through an unique FIX session (multilogon connection).....	13
3.6 Start of the FIX session	14
3.7 Synchronisation at application level	14
3.8 High availability	14
3.9 Reception of information for all traders of the member.....	15
3.10 Reception of information on actions taken on behalf of the trader.....	15
3.11 List of messages	16
3.12 Message flow	17
3.13 Annotations and adaptations of FIX 5.0.....	19
3.13.1 Standard Message Header	21
3.13.2 Standard Message Trailer.....	23
3.13.3 Logon (Msg Type = A)	24
3.13.4 Logout (Msg Type = 5).....	27
3.13.5 Heartbeat (Msg Type = 0).....	28
3.13.6 Test Request (Msg Type = 1)	29
3.13.7 Reject (Msg Type = 3).....	30
4 General conventions in application messages	31
4.1 Order identification	31
4.1.1 ClOrdID.....	31
4.1.2 OrderID.....	31
4.1.3 SecondaryOrderID.....	32
4.1.4 SecondaryExecID	32
4.2 Trade identification	32
4.2.1 ExecID	32
4.2.2 TrdMatchID	32
4.3 Parties block.....	33
4.4 Instrument block	37
4.4.1 SecurityType [167].....	38
4.4.2 Underlying asset (SecurityID [48] field).....	38
4.4.3 Expiration (MaturityMonthYear [200] field).....	38
4.4.4 Contract code (Symbol [55] field) or using the combination SecurityType [167] + PutOrCall [201] + SettlMethod [1193] + ExerciseStyle [1194] + EventText [868] when EventType [865] = 134 + SecurityID [48] + MaturityDate [541] + ContractMultiplier [231] + StrikePrice [202]	38
4.4.5 Combination of selection criteria.....	38
4.5 MultipleCharValue and SeqNum data types.....	39
4.6 Timestamp format	39
4.7 Implied subscription to Trading Session Status Request, Security List Request and Market Data Request.....	39
5 Common Application Messages	41
5.1 Introduction.....	41
5.2 Network communication status.....	41

5.3	Password change	41
5.4	Rejection of application messages	41
5.5	List of messages	42
5.6	Message flow	43
5.7	Annotations and adaptations of FIX 5.0.....	44
5.8	Definition of messages	45
5.8.1	<i>Network Counterparty System Status Request (Msg Type = BC)</i>	45
5.8.2	<i>Network Counterparty System Status Response (Msg Type = BD)</i>	46
5.8.3	<i>User Request (Msg Type = BE)</i>	47
5.8.4	<i>User Response (Msg Type = BF)</i>	48
5.8.5	<i>Business Message Reject (MsgType = j)</i>	49
6	Indications of Interest	50
6.1	Introduction.....	50
6.2	Description	50
6.3	List of messages	50
6.4	Message flow	51
6.5	Annotations and adaptations of FIX 5.0.....	52
6.6	Definition of messages	53
6.6.1	<i>Indication of Interest sent to HF MEFFGate (Msg Type = 6)</i>	53
6.6.2	<i>Indication of Interest sent by HF MEFFGate (Msg Type = 6)</i>	54
7	Order management and trades notification	55
7.1	Introduction.....	55
7.2	Order management on behalf of a trader	55
7.3	Enter orders.....	56
7.3.1	<i>Description</i>	56
7.3.2	<i>Order entry status</i>	56
7.3.3	<i>Supported order types and validity of orders</i>	56
7.3.4	<i>Order persistence on connection loss</i>	56
7.3.5	<i>List of messages</i>	57
7.3.6	<i>Message flow</i>	57
7.3.7	<i>Annotations and adaptations of FIX 5.0</i>	58
7.4	Modify orders.....	59
7.4.1	<i>Description</i>	59
7.4.2	<i>Order modification request status</i>	60
7.4.3	<i>List of messages</i>	60
7.4.4	<i>Message flow</i>	61
7.4.5	<i>Annotations and adaptations of FIX 5.0</i>	63
7.5	Cancel orders.....	64
7.5.1	<i>Description</i>	64
7.5.2	<i>Status of order cancellation request</i>	64
7.5.3	<i>List of messages</i>	65
7.5.4	<i>Message flow</i>	65
7.5.5	<i>Annotations and adaptations of FIX 5.0</i>	68
7.6	Mass cancellation of orders.....	69
7.6.1	<i>Description</i>	69
7.6.2	<i>Selection criteria</i>	69
7.6.3	<i>Status of mass cancellation request</i>	69
7.6.4	<i>ClOrdID field</i>	69
7.6.5	<i>List of messages</i>	70
7.6.6	<i>Message flow</i>	71
7.6.7	<i>Annotations and adaptations of FIX 5.0</i>	71
7.7	Notification of execution	72
7.7.1	<i>Description</i>	72
7.7.2	<i>Trade cancellation / Trade amendment</i>	72
7.7.3	<i>List of messages</i>	72
7.7.4	<i>Message flow</i>	73
7.7.5	<i>Annotations and adaptations of FIX 5.0</i>	73
7.8	Order Status Request.....	74
7.8.1	<i>Description</i>	74
7.8.2	<i>List of messages</i>	74
7.8.3	<i>Message flow</i>	75
7.8.4	<i>Annotations and adaptations of FIX 4.4</i>	75
7.9	Definition of messages	76
7.9.1	<i>New Order - Single (Msg Type = D)</i>	76
7.9.2	<i>Order Cancel Request (Msg Type = F)</i>	79
7.9.3	<i>Order Modification Request (Msg Type = G)</i>	80

7.9.4	Execution Report (Msg Type = 8)	84
7.9.5	Order Cancel Reject (Msg Type = 9)	96
7.9.6	Order Status Request (Msg Type = H)	98
7.9.7	Order Mass Cancel Request (Msg Type = q)	99
7.9.8	Order Mass Cancel Report (Msg Type = r)	101
8	Strategies	102
8.1	Introduction	102
8.2	List of messages	102
8.3	Message flow	103
8.4	Annotations and adaptations of FIX 5.0	103
8.5	Definition of messages	104
8.5.1	Security Definition Request (Msg Type = c)	104
8.5.2	Security Definition (Msg Type = d)	105
9	Delta Protection, Kill Button, Management of Filters and Permissions	107
9.1	Introduction	107
9.2	RegistID	108
9.3	Delta protection + Account configuration and MiFiD II tags for quotes	110
9.3.1	List of messages	111
9.3.2	Message flow	112
9.3.3	Annotations and adaptations of FIX 5.0	112
9.3.4	Definition of messages	114
9.4	Kill Button	122
9.4.1	List of messages	122
9.4.2	Message flow	122
9.4.3	Annotations and adaptations of FIX 5.0	123
9.4.4	Definition of messages	124
9.5	Management of Price Filters	127
9.5.1	List of messages	127
9.5.2	Message flow	127
9.5.3	Annotations and adaptations of FIX 5.0	128
9.5.4	Definition of messages	129
9.6	Management of Volume Filters	135
9.6.1	List of messages	135
9.6.2	Message flow	136
9.6.3	Annotations and adaptations of FIX 5.0	136
9.6.4	Definition of messages	138
9.7	Management for HFT – IFTL (Maximum variation of the position)	142
9.7.1	List of messages	142
9.7.2	Message flow	142
9.7.3	Annotations and adaptations of FIX 5.0	143
9.7.4	Definition of messages	144
9.8	Management of Permissions	148
9.8.1	List of messages	148
9.8.2	Message flow	148
9.8.3	Annotations and adaptations of FIX 5.0	149
9.8.4	Definition of messages	150
10	Quote management	154
10.1	Introduction	154
10.2	Configuration of the quote parameters: Account configuration and MiFiD II tags and delta protection	155
10.2.1	Introduction	155
10.2.2	Description	155
10.3	Enter quotes	156
10.3.1	Description	156
10.3.2	List of messages	156
10.3.3	Message flow	157
10.3.4	Annotations and adaptations of FIX 5.0	159
10.4	Modify quotes	160
10.4.1	Description	160
10.4.2	List of messages	160
10.4.3	Message flow	161
10.4.4	Annotations and adaptations of FIX 5.0	164
10.5	Cancel quotes	165
10.5.1	Description	165
10.5.2	Selection criteria	165
10.5.3	List of messages	165

10.5.4	Message flow	166
10.5.5	Annotations and adaptations of FIX 5.0	167
10.6	Notification of quote execution	168
10.6.1	Description	168
10.6.2	List of messages	168
10.6.3	Message flow	168
10.6.4	Annotations and adaptations of FIX 5.0	168
10.7	Quote Status Request	169
10.7.1	Description	169
10.7.2	List of messages	169
10.7.3	Message flow	169
10.7.4	Annotations and adaptations of FIX 4.4	169
10.8	Definition of messages	170
10.8.1	Quote (Msg Type = S)	170
10.8.2	Quote Cancel (Msg Type = Z)	171
10.8.3	Quote Status Request (Msg Type = a)	172
10.8.4	Quote Status Report (Msg Type = AI)	173
11	Cross trades	177
11.1	Introduction	177
11.2	Entry of cross trades between different members	177
11.3	Acceptance of cross trades between different members	178
11.4	Entry of cross trades within the member	178
11.5	Price and Effective amount	179
11.6	Cross trade groups and cash market cross trades	179
11.7	Cross trade rejected by the System	179
11.8	List of messages	179
11.9	Message flow	180
11.10	Annotations and adaptations of FIX 5.0	183
11.11	Definition of messages	184
11.11.1	Trade Capture Report (Msg Type = AE) sent to HF MEFFGate	184
11.11.2	Trade Capture Report (Msg Type = AE) sent by HF MEFFGate	191
12	Request for Quote modality	198
12.1	Introduction	198
12.2	Description	198
12.3	Message list	200
12.4	Message flow	201
12.5	Annotations and adaptations of FIX 5.0	203
12.6	Message definition	204
12.6.1	Quote Request (Msg Type = R)	204
12.6.2	Quote Response sent by HF MEFFGate (RFQ status) (Msg Type = AJ)	209
12.6.3	Quote Response sent to HF MEFFGate (Msg Type = AJ)	215
12.6.4	Quote Request Reject rejecting a Quote Request (Msg Type = AG)	220
13	Communication of Events	221
13.1	Introduction	221
13.2	List of messages	221
13.3	Message flow	221
13.4	Annotations and adaptations of FIX 5.0	221
13.5	Definition of messages	222
13.5.1	News (Msg Type = B)	222
	MEFF Order Types	223
	User Fields	224

1 Introduction

1.1 Scope of this manual

This document contains the definition of the MEFF trading system interface provided by MEFF for developing external applications. The interface is based on version 5.0 of the FIX Protocol standard (Financial Information exchange). More detailed information about the standard can be found in reference document 1 (see 1.5) or on the website www.fixprotocol.org.

The interface follows the FIX 5.0 specifications, as far as possible. In the majority of cases the structure and semantics of the messages are identical to the standard.

In some cases, the protocol has been extended to cover functions not considered by the standard. These extensions are clearly detailed in the document.

In other cases, the standard is ambiguous or indicates that the details should be mutually defined by the parties. In these cases the manual provides a detailed description to avoid any possible ambiguity.

All annotations and adaptations of the standard have been done in accordance with the recommendations in the standard.

To avoid possible duplication in the sources of information, this document does not include explanations of those matters that comply exactly with the standard. Therefore, the standard documentation should be considered as the main source of information for any matter that is not explicitly covered in this manual.

This is a reference document for those Members and ISVs that wish to develop software that can process private data using the HF MEFFGate server FIX interface.

1.2 Private information

The following table displays the private functions and their related messages.

Private function	Related messages
Order management	New Order – Single
	Order Cancel Request
	Order Modification Request
	Execution Report
	Order Cancel Reject
	Order Status Request
	Order Mass Cancel Request
	Order Mass Cancel Report
	Security Definition Request
Strategies definition	Security Definition
	Quote
Quote management (an order with buy + sell sides)	Quote Status Report
	Execution Report
	Quote Cancel
	Quote Status Request
	Trade Capture Report
Cross trades within the member, block trading and special operations	Execution Report
	News
Send messages to market supervisor and Reception of administrator's messages	News
Indications of Interest	Indication of Interest
Request for Quote	Quote Request
	Quote Request Reject
	Quote Response
Delta Protection, Kill Button, Filters Management and Permissions	Registration Instructions
	Registration Instructions Response

1.3 Structure of manual

The manual is divided into two parts. The first part, containing the first four chapters, gives a description of generic features of this interface.

This first chapter describes the scope of the document, its structure and introduces the related documents.

Chapter 2 “Implementation decisions” presents those annotations or restrictions arising from the implementation of the protocol defined in this manual.

Chapter 3 “FIX Session” describes those aspects related to the session level, including the detailed description of the corresponding messages.

Chapter 4 “General conventions in application messages” describes in detail specific aspects that affect the majority of the messages described in this manual.

Given the generic nature of the content, which affects all the messages, it is recommended to read chapters 2, 3 and 4 before considering other chapters.

The second part of the manual, containing the remainder of the chapters, describes the different functions supported by HF MEFFGate. Each of these chapters deals with a specific function, describing specific matters of interest.

Each of these chapters contains the following sections:

- **Introduction.** A brief description of the function covered in the chapter
- **List of messages.** List of the different messages implemented by the function
- **Message flow.** Description of the different scenarios for message exchange that may arise, with the corresponding message flow diagrams
- **Annotations and adaptations of FIX 5.0.** Details the annotations and adaptations that MEFF has made to the standard protocol to meet its needs
- **Definition of messages.** Contains a table for each message in the chapter, describing the message fields in detail

Finally, various tables providing information referred to throughout the document are included as appendices.

1.4 Format of the message definition tables

As explained in the previous section, a table for each message is included in those chapters where it is necessary, describing the component fields in detail.

These tables contain one field per row and have the following columns:

Column	Meaning
Tag	Field number. The fields added to the message in this implementation have an asterisk (“*”) after the number
Name	Name of field according to the FIX standard
Req	“Y” indicates that the field is required; “N” means that the field is optional. “Y*” means that the field is required in this implementation, but it is optional in the FIX 5.0 standard
Valid values	Accepted values for the field in the context of the message. It may be a list of values, or a range of numeric values, e.g. “>=3, <= 10”. The default value for the field is also indicated in this column. To avoid confusions with the terms, the original FIX value description has been respected in the values associated with codes.
Format	Type of data in the field. It is one of the types defined by FIX, or one of these types with some additional restriction. String(n) is a String type with a maximum of n characters, or in some cases with exactly n characters. For more information on the String type, see 2.4
Description	Description of the field in the context of the message

1.5 Related documents

#	Title	Author
1	Financial Information Exchange Protocol (FIX) 5.0 Service Pack 2 (9 December 2013) EP98-222 enhancing FIX 5.0 SP2	FIX Committee
2	HF MEFFGate – FIX Interface Specifications M5.4	MEFF

2 Implementation decisions

2.1 Description

This chapter presents the implementation decisions made by MEFF. Those aspects that the standard leaves open and have been defined in this implementation are detailed here.

2.2 Fields ignored

In some cases, the content of certain fields of the entering messages may be ignored by HF MEFFGate. When this is the case, it is clearly stated in the field description.

2.3 Unsupported fields

The unsupported fields of a message are not included in its description.

Messages sent to HF MEFFGate should not contain unsupported fields. Messages sent by HF MEFFGate never contain unsupported fields.

No required fields have been declared unsupported.

2.4 Length of String type

The FIX standard does not place any restriction on the maximum length of the String type. In this implementation the maximum length is 255 characters.

In some fields, a shorter maximum length has been established. In these cases, the type is presented as String(n), where “n” is the maximum number of characters of the field. In certain cases “n” indicates the exact length of the field, in which case it will be explicitly stated in the valid values column.

2.5 Maximum length of message

The maximum length of the messages sent or received by HF MEFFGate is 4096 bytes.

2.6 Encryption

HF MEFFGate does not use the encryption defined in the FIX standard (using the SecureData and SecureDataLen fields in the message header). The encryption is implemented through the use of SSL (*Secure Socket Layer*).

2.7 Identification of the HF MEFFGate FIX protocol

HF MEFFGate implements an additional function that allows both parties to agree on the HF MEFFGate FIX version that they are going to use.

It is important to distinguish between the version of the FIX protocol (in this case “5.0”) and the version of the HF MEFFGate FIX protocol (“T5.4” in this edition).

More than one version of the HF MEFFGate FIX protocol may exist for the same version of FIX.

If the version requested by the client program is not available in the HF MEFFGate server in use, it will return a Logout Message with the corresponding explanatory message.

3 FIX Session

3.1 Introduction

The level of the FIX session guarantees the complete delivery of messages between both parties, without errors. HF MEFFGate implements the majority of the functions of the session level defined in the FIX 5.0 standard

3.2 FIX session and communication session

There are two types of session:

- **Communication session.** It begins when opening the socket (ip-address and port assigned to this service). It ends when the socket is closed.
- **FIX session.** This begins when a request to start a session (Logon message) is accepted. It ends when the communication is completed, preferably with the exchange of Logout messages This is a combination of two-way messages identified by a sequence of consecutive numbers. A FIX session begins when the sequence numbers of both parties are restarted with the value 1. There is no explicit way of ending a FIX session; a session ends when a new one begins.

In addition to the two mentioned types of sessions, the trading session should also be considered. A trading session in an environment begins each day when the HF MEFFGate server loads the trading system data and accepts connections for said session.

The client program must begin a new FIX session in every communication session.

Given that HF MEFFGate does not provide 24-hour support for the service, the ResetSeqNumFlag field is not required in the Logon message.

3.3 Identification of the FIX session

Once a communication session has been established, HF MEFFGate identifies the associated FIX session using four fields in the Logon message sent by the initiator:

- SenderCompID
- SenderSubID
- TargetCompID
- TargetSubID

SenderCompID identifies the member and SenderSubID identifies the trader. TargetCompID together with TargetSubID identify the environment.

No more than one FIX session can exist at a time with the same values for these four fields.

The SenderCompID, SenderSubID, TargetCompID and TargetSubID fields are present in all the FIX messages. All the messages belonging to the same FIX session must have the same values in these fields. If a message is received with values that do not correspond with those of the session, it will be rejected with a Reject message.

It should be noted that the values of these fields are inverted when the message is sent by HF MEFFGate, with respect to those sent by the client. Suppose that trader “001” of member “A001” has a session established with the Financial Contract Group at MEFF. The messages will be those shown below:

Client message to HF MEFFGate:

- SenderCompID = “A001”
- SenderSubID = “001”
- TargetCompID = Operating MIC
- TargetSubID = “M3” *

HF MEFFGate message to client:

- SenderCompID = Operating MIC
- SenderSubID = “M3”
- TargetCompID = “A001”
- TargetSubID = “001”

The list of values for TargetCompID/SenderCompID is located in codification table 33.

The list of values for TargetSubID/SenderSubID is located in codification table 17.

3.4 Client software and FIX sessions

A HF MEFFGate client is a software development that connects to MEFF through a HF MEFFGate server.

As noted in 3.3, a FIX session is limited to one user and one contract group. A client will be able to establish various FIX sessions simultaneously to access more than one contract group or trade in one contract group with various user codes.

A HF MEFFGate server can provide service to various sessions simultaneously, be they of the same client or various clients.

When a FIX client tries to connect with a contract group that is not available, his Logon message is answered with a Logout message with the appropriate explanation.

3.5 Message routing from different users through an unique FIX session (multilogon connection)

HF MEFFGate allows to establish, through an unique FIX session, a message routing from different traders who have the appropriate privileges. This is a multilogon connection.

For this purpose, the following tags from the Standard Message Header are used in application messages: OnBehalfOfCompID [115], OnBehalfOfSubID [116], DeliverToCompID [128] and DeliverToSubID [129].

It should be noted that the tags OnBehalfOfCompID [115] and OnBehalfOfSubID [116] are used when the client application sends application messages to HF MEFFGate. Tags DeliverToCompID [128] and DeliverToSubID [129] are used when HF MEFFGate sends application messages to the client application.

* See table 17 of document “Codification Tables” for a list of available Contract Groups

Application message to HF MEFFGate:

- OnBehalfOfCompID = "B001"
- OnBehalfOfSubID = "351"

Application message to client:

- DeliverToCompID = "B001"
- DeliverToSubID = "351"

3.6 Start of the FIX session

On initiating a new communication session (opening a new socket), the client must initiate a new FIX session. The value to be used in the MsgSeqNum field of the Logon message must be 1.

3.7 Synchronisation at application level

When a client starts a FIX session (Logon message accepted), it receives a series of information related with the current Market session.

To synchronise at the application level, the client may use the tags ApplID [1180] + ApplSeqNum [1181]. Value 0 in ApplID [1180] and ApplSeqNum [1181] means updates from the beginning of the business session. If this field is not specified, then the classical behaviour is assumed (snapshot of the current situation and updates from this time).

It should be taken into account that any subscription to information is cancelled when the communication session ends. If this service is required when reconnecting to a new session, it must be requested again.

The series of private messages not associated to subscriptions referred to in this section correspond to the following messages:

- Execution Report with the ExecType [150] values of New ("0"), Replace ("5"), Cancelled ("4"), Trade ("F") and Trade Cancel ("H")
- News
- Quote Status Report corresponding to the current situation of each quote
- Trade Capture Report (from all the traders of the member)
- Quote Response
- Registration Instructions Response (delta protection, user's established permissions, volum filters and price filters and when the user has the relevant permissions, those of the other traders of the entity and of the members cleared by the entity, ...)

3.8 High availability

To improve the availability of access to MEFF there will be various instances of the HF MEFFGate server executing in different computers.

All the instances of HF MEFFGate will be connected with the central systems of MEFF. Therefore, they will have all the necessary information.

When a HF MEFFGate server fails, the client can continue working with another HF MEFFGate. The client must carry out the necessary processes to synchronise at the application level using the tags ApplID [1180] + ApplSeqNum [1181].

When a client application that has established a FIX session fails, the client application can restart in another computer that continues with the same session (using the same HF MEFFGate server).

In this case, HF MEFFGate will not request the client application resending any unprocessed messages.

3.9 Reception of information for all traders of the member

Members can request the configuration of privileged traders that will receive the order related messages sent to all the traders of the member.

The messages affected by this mechanism are the Execution Report which contains the following values in the ExecType [150] field: New ("0"), Cancelled ("4"), Replace ("5"), Trade ("F"), Trade Cancel ("H") and the Quote Status Report.

The messages sent by HF MEFFGate to this user contain the same information as the original messages, except for the TargetCompID and TargetCompSubID fields. When necessary, the information contained in the Parties block allows identification of the target trader in the original message.

3.10 Reception of information on actions taken on behalf of the trader

MEFF's technological platform enables actions to be taken on behalf of a trader. This can be done, for instance, from a Multi-Trader station of the member or by the MEFF Market Surveillance.

In these cases, the FIX client on whose behalf the action has been made, receives the messages corresponding to said operative. Accordingly, **client applications must be prepared to receive messages originated by actions of third parties in their name.**

Note that in this case, the number of messages received by the client application can be less than it would have received if it had sent the equivalent message. The messages that are not received are those generated directly from HF MEFFGate to notify the reception of the message and sending the same message to the central systems.

When necessary, the information contained in the Parties block (see 0) allows the member and trader who undertook the action to be identified.

3.11 List of messages

The functionality at the session level is implemented in FIX 5.0 using five administrative messages. All these are fully supported by the HF MEFFGate FIX protocol.

Message	Description
Logon (Msg Type = A)	Request or confirmation of the start of a communication session
Logout (Msg Type = 5)	Request or confirmation of the end of a communication session
Heartbeat (Msg Type = 0)	Periodic notification that the connection continues to be live
Test Request (Msg Type = 1)	Request to send a Heartbeat message to confirm that the connection is alive
Reject (Msg Type = 3)	Reject a message at session level

3.12 Message flow

Start of communication session and start of FIX session

A request to start a communication session (Logon message) that is accepted is replied to by the receiver with another Logon message. The initiator must not send another message until it has received this confirmation of acceptance.

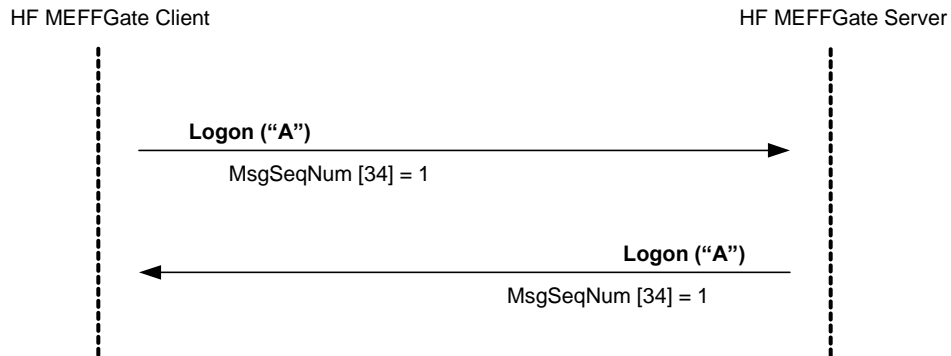

Start of communication session rejected

When the start of a communication session (Logon message) is not accepted, HF MEFFGate will reply with a Logout message.

For more details on the behaviour of sequence numbers of both parties see section 3.6.

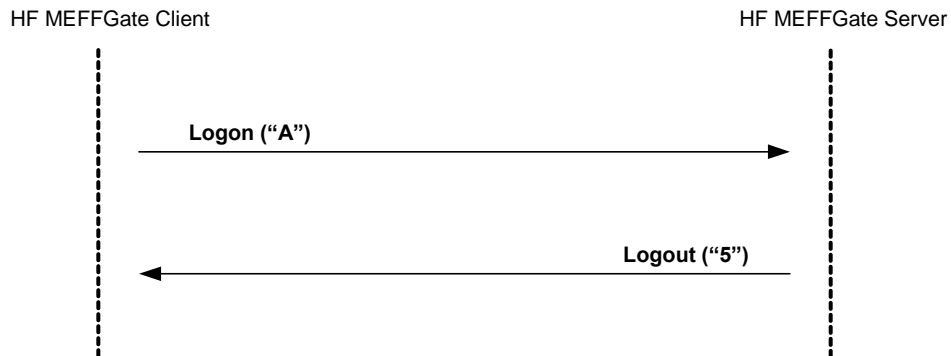

End of a communication session started by the sender

The client can end the communication session by sending a Logout message at any time.

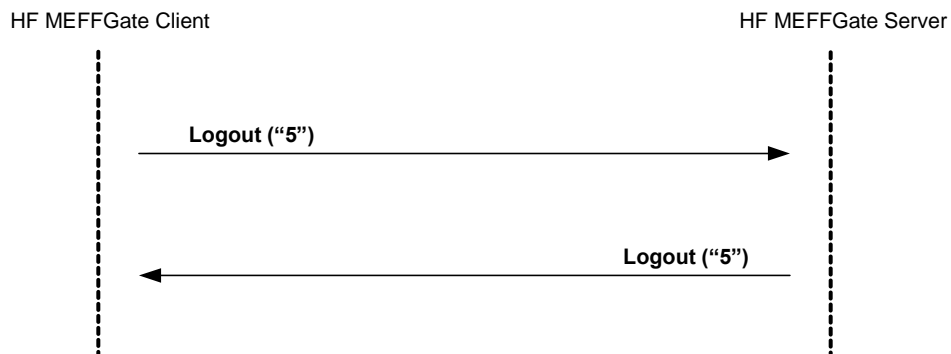

End of a communication session started by the receiver

In exceptional circumstances, the server can end the communication session with a Logout message.

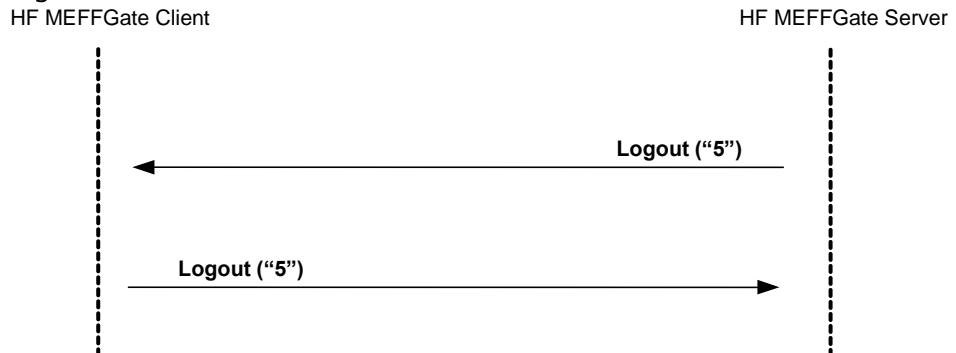

Sending messages with identification fields of session (SenderCompID, SenderSubID, TargetCompID and TargetSubID) with different values from those associated to the current FIX session

All the messages associated to a FIX session must include the same identifying values of the session (SenderCompID, SenderSubID, TargetCompID and TargetSubID). If a message differs from the values indicated in the Logon of the session, it is rejected with a Reject message.

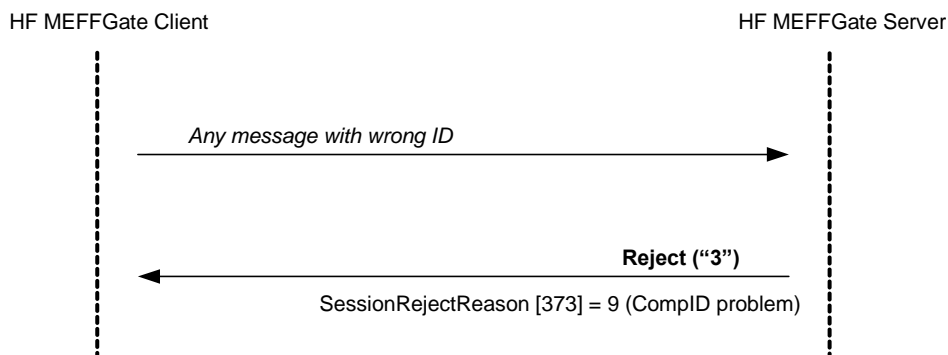

3.13 Annotations and adaptations of FIX 5.0

- The user optional field ReceivePendings [5678] has been added to the Logon message to Indicate whether the receipt of Execution Reports pending confirmation is required or not
- The user optional field LocalMktTimestamp [21501] has been added to the Logon message to Indicate for all tags in which a timestamp is included, the timestamp format (UTC format or local market time)
- The user optional field AutoSubscriptionsID [21502] has been added to the Logon message to Indicate an implied subscription to Trading Session Status Request Security List Request and Market Data Request
- The user optional field ExecutionsOnly [21503] has been added to the Logon message to Indicate the user wants to receive trades only
- The user field MaxMsgPerSecond [21504] has been added to the Logon message sent by HF MEFFGate to indicate the maximum number of messages per second that can be sent, as contracted for the client
- The user field BusinessSessionDate [21505] has been added to the Logon message sent by HF SMARTGate to inform the current business session date.
- The optional fields ApplID [1180] and ApplSeqNum [1181] have been added to the Logon message to indicate that only updates from the point indicated are requested
- The Text [58] and DefaultCstmAppVerID [1408] fields in the Logon message are now required
- When a request to start a session (Logon message) is rejected, the receiver (MEFF) will always send a Logout message in reply
- The SenderSubID [50] and TargetSubID [57] fields in the header of messages (Standard Message Header) are now required
- The FIX method of encryption is not supported
- The Resend Request and Sequence Reset messages are not supported (and rejected by HF MEFFGate)
- The only valid value of the ResetSeqNumFlag [141] field in the Logon message is "N"

3.13.1 Standard Message Header

Header is present in all FIX messages.

Tag	Name	Req	Valid values	Format	Description
8	BeginString	Y	FIXT.1.1	String	Indicates the start of a new message. It is always the first field of the message
9	BodyLength	Y		Int	Length of message in bytes, from the end of this field up to and including the delimiter before the Checksum field. It is always the second field of the message
35	MsgType	Y	All message types supported by MEFF	String	Identifies the type of message. It is always the third field of the message
					Identifier of the entity that sends the message.
49	SenderCompID	Y	See chapter "3.3 - Identification of the FIX session"	String	It contains the operating MIC of the venue (see table 33 document "Codification tables") when the message is sent by HF MEFFGate. It must contain the member code in the messages sent by the client application.
					Identifier of the entity that the message is sent to.
56	TargetCompID	Y	See chapter "3.3 - Identification of the FIX session"	String	It should contain the operating MIC of the venue (see table 33 document "Codification tables") when the message is sent to HF MEFFGate, although HF MEFFGate ignores the content of this field. It contains the member code in the messages sent by HF MEFFGate.
115	OnBehalfOfCompID	N		String	Used by client when sending messages via a third party who has the appropriate privileges
128	DeliverToCompID	N		String	Used by HF MEFFGate when receiving messages via a third party who has the appropriate privileges
34	MsgSeqNum	Y		SeqNum	Sequence number of the message within the current FIX session
50	SenderSubID	Y*	See chapter "3.3 - Identification of the FIX session"	String	The messages sent from HF MEFFGate to the client contain the code assigned to the contract group with which the connection was established (see table 17 document "Codification tables").

Tag	Name	Req	Valid values	Format	Description
					Messages sent to HF MEFFGate must contain the trader code with which the FIX session was started
57	TargetSubID	Y*	See chapter "3.3 - Identification of the FIX session"	String	The messages sent from HF MEFFGate contain the code of the trader which it is to be sent to. Messages sent to HF MEFFGate must contain the code of the contract group with which the connection was established (see table 17 document "Codification tables")
116	OnBehalfOfSubID	N		String	Used by client when sending messages via a third party who has the appropriate privileges
129	DeliverToSubID	N		String	Used by HF MEFFGate when receiving messages via a third party who has the appropriate privileges
52	SendingTime	Y		UTC Timestamp	Time message sent

3.13.2 Standard Message Trailer

Present in all FIX messages.

Tag	Name	Req	Valid values	Format	Description
10	Checksum	Y		String(3)	Checksum of the message, calculated in accordance with the standard. It is always the last field of the message and its length is exactly 3 bytes

3.13.3 Logon (Msg Type = A)

The Logon message is used to start a session by the client application and to accept it by the HF MEFFGate.

Tag	Name	Req	Valid values	Format	Description
	Standard Header	Y	MsgType = A		
98	EncryptMethod	Y	0 = None	Int	Ignored by HF MEFFGate
108	HeartBtInt	Y	>=1	Int	Interval at which messages are sent to verify the connection (Heartbeat message) expressed in seconds.
141	ResetSeqNumFlag	N	N	Boolean	Only allows the value "N", as it is not required in the implementation of the protocol
789	NextExpectedMsgSeqNum	N		SeqNum	If informed only value 1 is allowed
464	TestMessageIndicator	N	Y = Test N = Production	Boolean	Indicates whether it is a test or production session. The client can use it optionally to indicate if it wants to connect to the production or test environment. The start of a session is accepted only if this environment is valid for the HF MEFFGate If the client does not indicate anything, this parameter is not taken into account. In any event HF MEFFGate always informs this field
553	Username	N		String	Identifier of the user assigned by MEFF. Required when the message is sent by the client application. It is currently comprised of the combination of the member code and the trader code assigned by MEFF
554	Password	N		String	User Password. Required when the message is sent by the client application
1137	DefaultAppVerID	Y	9	String	Value 9 refers to FIX50SP2
1408	DefaultCstmAppVerID	Y*	T5.4	String	Exact identification of the version of the protocol used and expected by the client application
58	Text	Y*		String	The client must include a descriptive string of the software name used by the FIX connection. This will be one that has passed the corresponding conformance test
1180*	AppID	N		String	If provided, only updates from the point indicated will be sent. This value, used in conjunction with ApplSeqNum [1181], should match the same field in any of the messages provided by the HF MEFFGate such as: Execution Report, Quote Status Report, Trade Capture Report ...

Tag	Name	Req	Valid values	Format	Description
					Required if ApplID [1180] is specified.
1181*	ApplSeqNum	N		SeqNum	This value, used in conjunction with ApplID [1180], should match the same field in any of the messages provided by the HF MEFFGate such as: Execution Report, Quote Status Report, Trade Capture Report ...
					Indicates that the receipt of Execution Reports pending confirmation is required or not. Possible values are:
5678*	ReceivePendings	N	Y, N (default)	Boolean	Y - All messages are sent N (default) - HF MEFFGate will not send Execution Report messages with OrdStatus [39] = A (Pending New), E (Pending Replace) or 6 (Pending Cancel) and QuoteStatus [297] = 10 (Pending)
					Indicates, for all tags in which a timestamp is included, the timestamp format:
21501*	LocalMktTimestamp	N	Y, N (default)	String	Y - HF MEFFGate will send the local market time (all messages up to microseconds) N - HF MEFFGate will send the time in UTC format according to the FIX standard (all messages up to microseconds)
					For more information see 4.6 Subscriptions identifier.
21502*	AutoSubscriptionsID	N		String(10)	If this tag is informed, a subscription to Trading Session Status Request Security List Request, Market Data Request (+Indication of Interest) is implied. Otherwise the classical behaviour is assumed.
					For more information see "4.7 - Implied subscription to Trading Session Status Request, Security List Request and Market Data Request"
21503*	ExecutionsOnly	N	Y, N (default)	Boolean	Indicates the user wants to receive trades only. Possible values are: Y - Only Execution Report messages with ExecType [150] = F (Trade) are

Tag	Name	Req	Valid values	Format	Description
					received. Also Quote Status Report messages will never be received
					N (default) - Classical behaviour
					Maximum number of messages per second that can be sent, as contracted for the client.
21504 *	MaxMsgPerSecond	N		Int	If the number of messages sent by the client application per second exceeds the number indicated, the client application could experience delays in processing the messages.
					This tag is only informed in the Logon response message sent by HF MEFFGate. The client application should not send this tag in the Logon message sent to HF MEFFGate.
					Current business session date.
21505 *	BusinessSessionDate	N		LocalMkt Date	This tag is only informed in the Logon response message sent by HF SMARTGate. The client application should not send this tag in the Logon message sent to HF SMARTGate.
	Standard Trailer	Y			

3.13.4 Logout (Msg Type = 5)

The Logout message is used by both parties to request the end of a communication session and to accept said request.

Tag	Name	Req	Valid values	Format	Description
	Standard Header	Y	MsgType = 5		
58	Text	N		String	Explanatory text
	Standard Trailer	Y			

3.13.5 Heartbeat (Msg Type = 0)

The Heartbeat message is used by both parties to indicate that the connection is active.

Tag	Name	Req	Valid values	Format	Description
	Standard Header	Y	MsgType = 0		
112	TestReqID	N		String	If the message is the reply to a Test Request message, it must contain the same value as the original TestReqID field. Otherwise, this field should be omitted.
	Standard Trailer	Y			

3.13.6 Test Request (Msg Type = 1)

The Test Request message is used by both parties to request that a Heartbeat message be sent.

Tag	Name	Req	Valid values	Format	Description
	Standard Header	Y	MsgType = 1		
112	TestReqID	Y		String	Identifier of the request. It must be included in the Heartbeat message reply
	Standard Trailer	Y			

3.13.7 Reject (Msg Type = 3)

The Reject message is used by HF MEFFGate to reject a message that does not comply with the FIX protocol specified by MEFF.

Tag	Name	Req	Valid values	Format	Description
	Standard Header	Y	MsgType = 3		
45	RefSeqNum	Y		SeqNum	Sequence number of the rejected message
			0 = Invalid tag number 1 = Required tag missing 2 = Tag not defined for this message type 3 = Undefined Tag 4 = Tag specified without a value 5 = Value is incorrect (out of range) for this tag 6 = Incorrect data format for value 9 = CompID problem 11 = Invalid MsgType 13 = Tag appears more than once 14 = Tag specified out of required order 15 = Repeating group fields out of order 16 = Incorrect NumInGroup count for repeating group 17 = Non "data" value includes field delimiter (SOH character) 99 = Other		
373	SessionRejectReason	N		Int	Code indicating the rejection motive
58	Text	N		String	Contains a more detailed explanation of the reason for the rejection
	Standard Trailer	Y			

4 General conventions in application messages

4.1 Order identification

4.1.1 CIOrdID

Any message related to an order (entry, cancellation, modification) sent by the client, must have a unique identifier in the CIOrdID field. The MEFF system enforces uniqueness of this identifier during the trading session, for the alive orders, at the contract level .

Once the message is accepted by HF MEFFGate, the client receives the corresponding confirmation message with the same CIOrdID code preceded by a prefix. It becomes the identifier of the order from this moment on. The client can now identify the order using either of the two CIOrdID values. MEFF implements this mechanism to ensure the unique identification of orders, independently of their issuer.

The only exception to the above occurs in the case of order cancellation *en masse*, where all the orders cancelled by this procedure are identified by the same CIOrdID. More information on this is provided in section 7.6.4.

The CIOrdID field assigned by the client must be 10 characters long or less. HF MEFFGate also accepts that messages sent by the client use a CIOrdID with a length of 30 characters, but in this case only the last 10 positions can be fixed freely, as the first 20 must coincide with the format that is shown below.

The CIOrdID assigned by the client is in the format YYMMDDMmmTttOoooSssNnnnnnnnnn, where the coding is defined as follows:

- **YYMMDD**. The date of the trading session when the new order, order modification or order cancellation is issued
- **MmmTtt**. Contains the member and trader codes of the SenderCompID and SenderSubID fields from the heading of the original message
- **OoooSss**. Contains the member and trader codes that are indicated in the Parties block as Originating Firm and Originating Trader (see 0)
- **Nnnnnnnnnn**. The value assigned by the client to the CIOrdID in the original message

4.1.2 OrderID

The OrderID field is the order identifier assigned by the HF MEFFGate server.

This identifier is unique per contract group, member, trader and session date

It is maintained associated with the order, even after order modification.

For orders with GTD validity (in the Segment MIC where these orders are admitted), it is reset in each session; in this case, the corresponding Execution Report messages will be informed with ExecType [150] = D (Restated) and ExecRestatementReason [378] = 1 (Renewal / Restatement).

This field may be necessary to identify the order in communications with the Market by other means.

4.1.3 SecondaryOrderID

The SecondaryOrderID field is an order identifier assigned by the central trading system. The period in which the uniqueness of this field is guaranteed is determined by each central trading host.

4.1.4 SecondaryExecID

The field SecondaryExecID [527] informs the number of reported history of the order. Each time the status or the order is changed in the order book of the central system (modification, cancellation, trade) a new value is assigned to this field.

In the MEFF trading system, any state of a specific order can be identified by the combination of the fields SecondaryOrderID [198] + SecondaryExecID [527].

4.2 Trade identification

4.2.1 ExecID

The ExecID field is **not** an identifier of trades. It is an Execution Report message identifier.

4.2.2 TrdMatchID

The TrdMatchID field has the trade register number. This is the code assigned by the central trading system to the trade or the cross trade referred to in the message. The period in which the uniqueness of this field is guaranteed is determined by each central trading host.

4.3 Parties block

The Parties block (or the NestedParties block) is used in many application messages to specify the parties involved in the transaction.

In the detailed definition of the messages that this block contains, the block is incorporated exactly as shown below. The list of possible values is restricted by the specific characteristics of the message.

Tag	Name	Req	Valid values	Format	Description
	Start <Parties>				
453	NoPartyIDs	N		NumInGroup	
→ 448	PartyID	N		String	See section 4.3 - Parties block
→ 447	PartyIDSource	N	D = Proprietary/ Custom code P = Short code identifier	Char	Indicates the codification used in the PartyID field. MEFF's own codification is always used Required if the block is present <ul style="list-style-type: none"> Value "P" when PartyRole [452] = 3, 12 or 122 Value "D" for the rest
→ 452	PartyRole	N		Int	Indicates the role taken by the party indicated in the PartyID field
	End <Parties>				

Various roles are used in the messages contained in this manual. The interpretation of the PartyID field depends on the value of the PartyRole, as explained below:

– 1 (Executing Firm)

- **Send.** This value cannot be specified when sending messages
- **Receive.** When this value is specified, the PartyID field corresponds with the member code for the trader that sent the original message (acting in his own name or on behalf of another trader)

– 3 (Client ID)

When this value is specified, the PartyID field corresponds to the Short code Client identification

The following values are reserved and have a special meaning: 0 (No Client), 1 (AGGR), 2 (PNAL). See document "Guidelines. Transaction reporting, order record keeping and clock synchronization under MiFID II" published by ESMA on 10 October 2016

– 4 (Authenticating Firm)

When this value is specified, the PartyID field corresponds to the Short code to identify the Authenticating Firm (cash market cross trades request)

– 7 (Entering Firm)

- **Send.** When this value is specified, the PartyID field corresponds to the code of the member that acts as broker or intermediary in a cross trade or in an specific configuration of price and volume filters and delta protection. The use of this value are only allowed in the Trade Capture Report message and the Registration Instructions message, used to enter the trade code which acts an specific configuration of price and volume filters and delta protection. It only allows the member’s own code to be specified.
- **Receive.** When this value is specified, the PartyID field corresponds to the code of the member that acts as broker or intermediary in a cross trade or in an specific configuration of price and volume filters and delta protection.
- **11 (Order Origination Trader)**
 - **Send.** In general it is not necessary to use this field when sending messages. When this value is specified, the PartyID field corresponds with the code of the trader on whose behalf it is acting. In the Trade Capture Report message, used to enter cross trades, the trader associated to the legs of the cross trade can be indicated. Also the Registration Instructions message is used to enter the trade code which acts an specific configuration of price and volume filters and delta protection.
 - **Receive.** When this value is specified, the PartyID field corresponds with the trader code of the trading being handled
- **12 (Execution within Firm)**

When this value is specified, the PartyID field corresponds to the party for the Execution within Firm

The following value is reserved and has a special meaning: 3 (NORE). See document “Guidelines. Transaction reporting, order record keeping and clock synchronization under MiFID II” published by ESMA on 10 October 2016
- **13 (Order Origination Firm)**
 - **Send.** In general it is not necessary to use this field when sending messages. When this value is specified, the PartyID field corresponds with the code of the trading member on whose behalf it is acting. In Trade Capture Report message, used to enter cross trades, the buyer or seller firm can be indicated when this is different to the one who introduces the message. Also the Registration Instructions message is used to enter the trade code which acts an specific configuration of price and volume filters and delta protection
 - **Receive.** When this value is specified, the PartyID field corresponds with the member code of the trading being handled
- **17 (Contra Firm)**

In a Request for Quote conversation, this PartyID refers to the Member or Broker with whom the conversation is held.

– **36 (Entering Trader).**

- **Send.** When this value is specified, the PartyID field corresponds with the code of the trader that acts as broker or intermediary in a cross trade or in an specific configuration of price and volume filters and delta protection. The use of this value are only allowed in the Trade Capture Report message and the Registration Instructions message, used to enter the trade code which acts an specific configuration of price and volume filters and delta protection. Only allows the trader's own code to be specified.
- **Receive.** When this value is specified, the PartyID field corresponds to the code of the member that acts as broker or intermediary in a cross trade or in an specific configuration of price and volume filters and delta protection.

– **37 (Contra Trader)**

In a Request for Quote conversation, this PartyID refers to the Trader at the Member or Broker with whom the conversation is held.

– **59 (Executing Trader)**

- **Send.** This value cannot be specified when sending messages
- **Receive.** When this value is specified, the PartyID field corresponds with the code of the trader that sent the original message (acting in his own name or on behalf of another trader)

– **96 (Take-up Trading Firm)**

When this value is specified, the PartyID field corresponds to the Take-up Trading Firm.

– **122 (Investment Decision within Firm)**

When this value is specified, the PartyID field corresponds to the Short code to identify the party for the Investment Decision within Firm

The following value is reserved and has a special meaning: 0 (No decision within Firm). See document "Guidelines. Transaction reporting, order record keeping and clock synchronization under MiFID II" published by ESMA on 10 October 2016

The following flow diagram provides an example of the use of party blocks in an intervention made by the MEFF Market Surveillance on an order by trader 301 of member AAAA. In this example trader 305 is considered to be configured as a privileged trader and therefore will also receive the information on the trade of trader 301 (see 3.9 for more information on privileged traders).

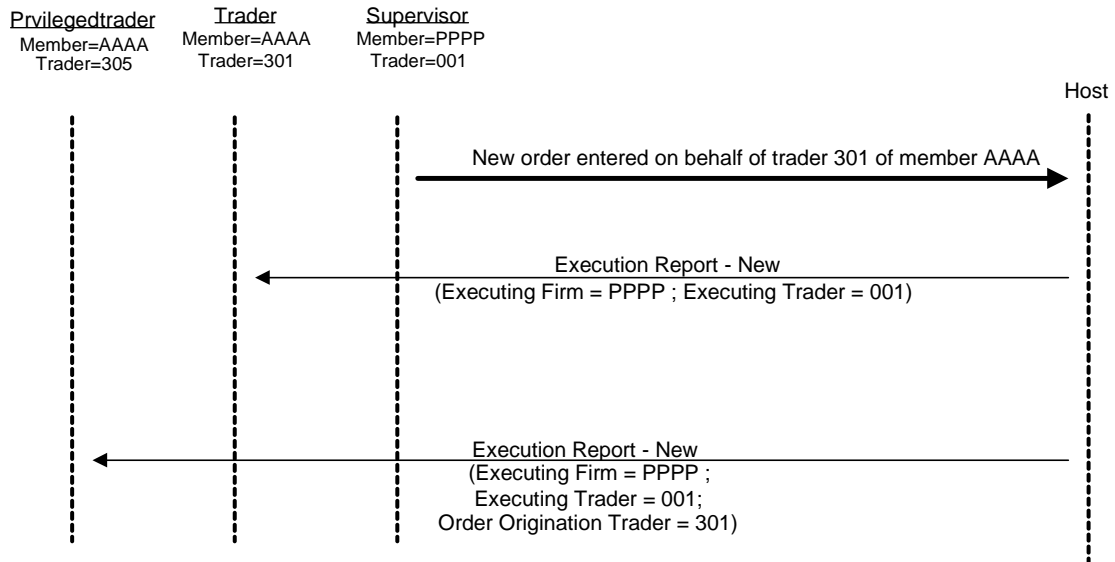

The next flow diagram provides an example of the use of party blocks in the entry of a cross trade by the MEFF Market Surveillance. In the example, expit trade trader 310 of member BBBB acts as intermediary and as one of the parties, whilst trader 301 of member AAAA acts as the other party. In this example trader 305 of member AAAA is configured as privileged trader and therefore also receives information on the trading activity of trader 301 of the same member (see 3.9 for more information on privileged traders).

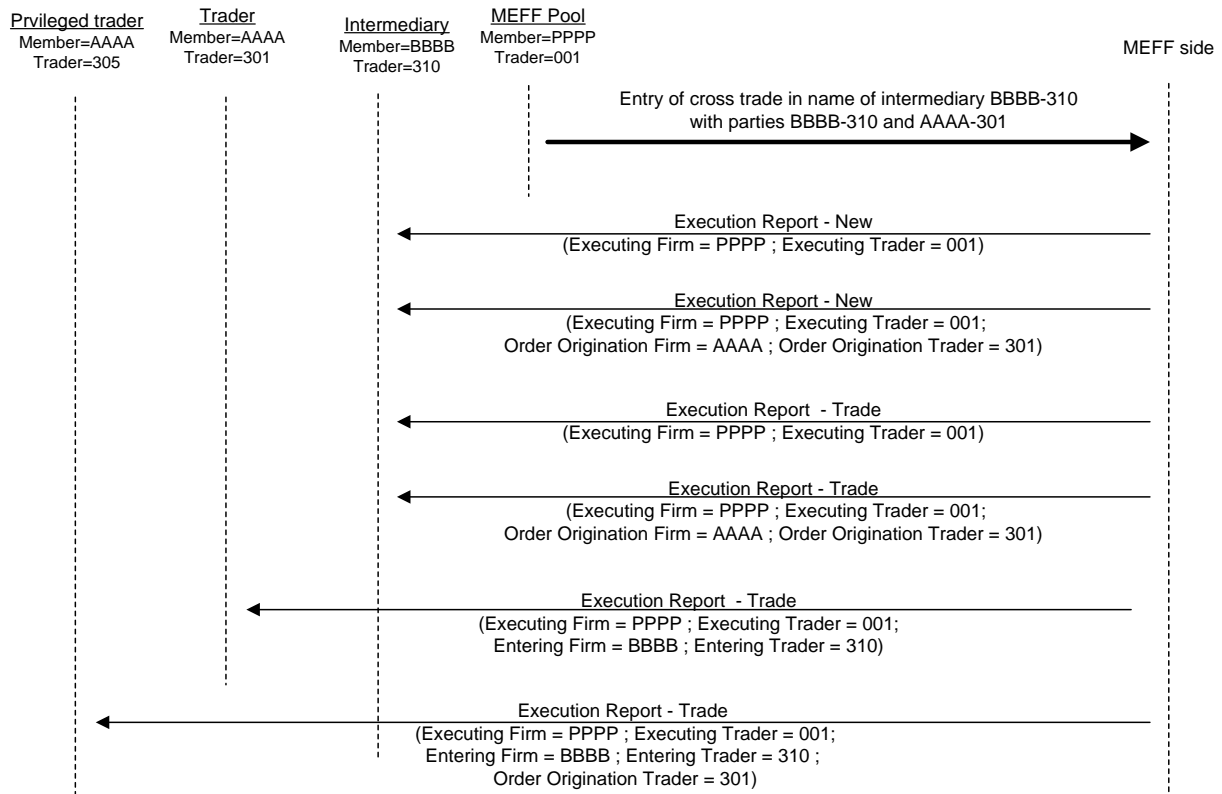

4.4 Instrument block

In mass cancel requests, such as Order Mass Cancel Request or Quote Cancel, the FIX client may specify selection criteria for the securities. In these cases, the cancellation will apply to the securities that meet these criteria. The possible selection criteria include fields of the Instrument block.

The table below indicates which fields are accepted by MEFF and the type of request that can be made.

Field	Meaning
SecurityType [167]	Product type
SecurityID [48]	MEFF Underlying asset
MaturityMonthYear [200]	Contract expiration
Symbol [55]	MEFF Contract code

The use of these fields is explained in detail in the following sub-sections.

4.4.1 SecurityType [167]

This code identifies the product type (see table 31 in document “Codification Tables”). Only messages sent by HF MEFFGate. Not allowed in messages sent by FIX client.

4.4.2 Underlying asset (SecurityID [48] field)

This code identifies the underlying asset of a contract (see table 21 in document “Codification Tables”).

4.4.3 Expiration (MaturityMonthYear [200] field)

For contracts with standard maturities, indicates the month and year when the contract expires. In this case, the format for this field is YYYYMM (e.g. 201312)

For contracts with non-standard maturities, indicates the date when the contract expires. In this case, the format for this field is YYYYMMDD (e.g. 20131219)

For contracts with week standard maturities, the format for this field is YYYYMMwW (e.g. 201312w2).

4.4.4 Contract code (Symbol [55] field) or using the combination SecurityType [167] + PutOrCall [201] + SettMethod [1193] + ExerciseStyle [1194] + EventText [868] when EventType [865] = 134 + SecurityID [48] + MaturityDate [541] + ContractMultiplier [231] + StrikePrice [202]

This is the most selective of the criteria, as it refers to a specific contract. MEFFGate allows a code 22 characters long. If you want to use the other selection criteria and do not want to specify a particular contract, complete this field with the value “[N/A]”, as indicated in the FIX standard specifications.

To identify a non-standard (flexible) contract that doesn't exist in the system, tag FlexibleIndicator [1244] and also the following combination should be used in the cross trade functionality: SecurityType [167] + PutOrCall [201] + SettMethod [1193] + ExerciseStyle [1194] + EventText [868] when EventType [865] = 134 + SecurityID [48] + MaturityDate [541] + ContractMultiplier [231] + StrikePrice [202], with Symbol [55] = [N/A]. In this case, where appropriate, MEFFGate FIX will assign a new code following the existing rules and will populate these fields in all the messages associated (Trade Capture Report and Trade Capture Report Ack). For all other situations the contract is identified as usual, using the tag Symbol [55].

4.4.5 Combination of selection criteria

When various selection criteria are combined, only those contracts that meet all the requirements are selected. When a selection criteria is not specified it is understood that this criteria is to be ignored and no contract will be discarded for this reason.

The following table shows some examples for the Financial Contract Group at MEFF.

SecurityType [167]	SecurityID [48]	MaturityMonthYear [200]	Symbol [55]	Meaning
F	FIE	(omitted)	[N/A]	All futures on IBEX index
F	BBVA	(omitted)	[N/A]	All the BBVA futures contracts with physical delivery
(omitted)	FIE	201203	[N/A]	All the contracts with IBEX index as underlying, with March 2012 expiration
O	(omitted)	201206	[N/A]	All options with June 2012 expiration
R	TEF	(omitted)	[N/A]	All time-spread contracts where Telefonica stocks is underlying of at least one leg
(omitted)	(omitted)	(omitted)	<specific contract>	The contract specified
(Omitted)	(Omitted)	(omitted)	[N/A]	All contracts
X	(any)	(any)	(any)	<u>Wrong selection criteria</u>

4.5 MultipleCharValue and SeqNum data types

According to the FIX standard, the data type MultipleCharValue is a string field containing one or more space delimited single character values (e.g. "18 = C o").

SeqNum data type is an int field and value must be positive. The client application must be ready to receive values greater than 2^{31} .

4.6 Timestamp format

The system permits the user to define, for all tags in which a timestamp is included, whether the format is UTC (according to the FIX standard), or the local market time.

For this functionality the user defined tag LocalMktTimestamp [21501] is used in the Logon message.

When this tag is used, with LocalMktTimestamp [21501] = "Y", HF MEFFGate will send the local market time (all messages up to microseconds).

If this tag is not used (or LocalMktTimestamp [21501] = "N"), HF MEFFGate will send the time in UTC format (all messages up to microseconds).

4.7 Implied subscription to Trading Session Status Request, Security List Request and Market Data Request

The system permits the user to establish an implied subscription to Trading Session Status Request Security List Request, Market Data Snapshot Full Refresh and Indication of Interest. For this functionality the user defined tag AutoSubscriptionsID [21502] is used in the Logon message.

When this tag is used, i.e. when AutoSubscriptionsID [21502] is informed, HF MEFFGate will send Trading Session Status, Security List, Security Status and Market Data Snapshot Full Refresh when the Logon handshaking has been met, if tags ApplID [1180] and ApplSeqNum [1181] are not informed.

It should be taken into account that the information provided in the Market Data Snapshot Full Refresh message, for every security, for: the Opening Price, Settlement Price, Trading session high price, Trading session low price, Trading session VWAP price, Trade volume (total volume for contract in session), and Prior settlement price. In other words, it is as if we were a subscription to Market Data Request restricted to MDEntryType = 4 (Opening Price), 6 (Settlement Price), 7 (Trading Session High Price), 8 (Trading Session Low Price), 9 (Trading Session VWAP Price), B (Trade Volume) and M (Prior Settlement Price).

In case of synchronisation using tags ApplID [1180] y ApplSeqNum [1181], the client application will receive updates from the point indicated for Trading Session Status, Security List Update Report and Security Status messages.

The identifiers TradSesReqID [335] (Trading Session Status), SecurityReqID [320] (Security List and Security List Update Report), SecurityStatusReq [324] (Security Status) and MDReqID [262] (Market Data Snapshot Full Refresh) will have the value informed in AutoSubscriptionsID [21502].

If this tag is not used, HF MEFFGate will assume the classical behaviour.

5 Common Application Messages

5.1 Introduction

This chapter presents some common messages at the application level that cover three functions: the control of the communication status, the individual user password change and the rejection of messages by HF MEFFGate.

5.2 Network communication status

HF MEFFGate includes a mechanism to inform the client application of the status of communication between HF MEFFGate itself and the central system. This functionality is achieved using the FIX Network Status messages.

HF MEFFGate will always send Network Counterparty System Response messages reporting on status of connection between HF MEFFGate and the central systems (whether or not the client subscribed to it).

The information supplied with these messages only refers to the connection between the equipment and should not be confused with the status of the trading session, which is covered in 6.2.

To find out when the FIX connection is online and therefore able to know the response messages by the central systems, we must analyze the tag StatusValue [928], Network Counterparty System Status Response ("BD") message, to be equal 1 (Connected). At the beginning of the connection this value is 4 (In Process) and remains at this value until the HF MEFFGate has processed all initialization messages, at which time its value is 1 (Connected). State 2 (Not connected - down expected up) usually corresponds to a communication breakdown in some point between HF MEFFGate and host. Finally, state 3 (Not connected - expected down down) usually corresponds to that has been closed communication with the central systems due to a normal end of session.

5.3 Password change

This functionality allows to change the individual user password used in the connection between the client application and HF MEFFGate.

The new password is valid for all the next future communication sessions between the client application and HF MEFFGate.

5.4 Rejection of application messages

When HF MEFFGate receives a supported message with correct syntax in an unsupported situation, but there is no specific rejection message, the Business Message Reject is used. In particular, this is used to reject the Network Counterparty System Status Request message.

5.5 List of messages

Message	Description
Network Counterparty System Status Request (Msg Type = BC)	Request of connection status between HF MEFFGate and the central systems
Network Counterparty System Status Response (Msg Type = BD)	Report on status of connection between HF MEFFGate and the central systems
User Request (Msg Type = BE)	Individual user password change request
User Response (Msg Type = BF)	Reply to a User Request message
Business Message Reject (MsgType = j)	Rejection of message at application level (used when there is no specific message)

5.6 Message flow

Subscription to connection status

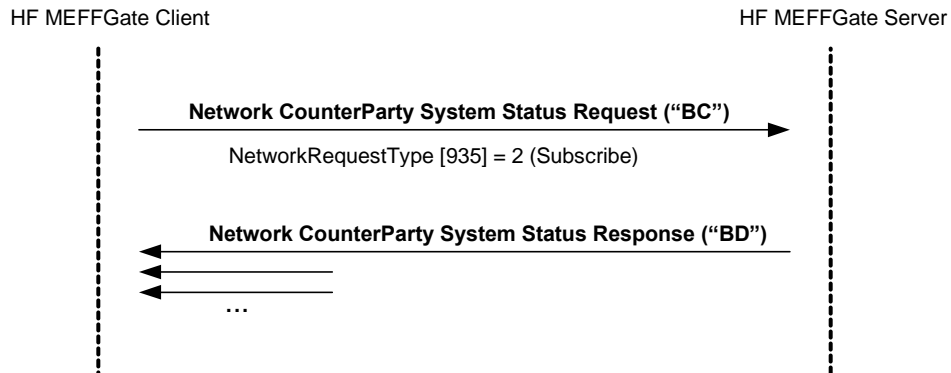

Report on connection status without any subscription

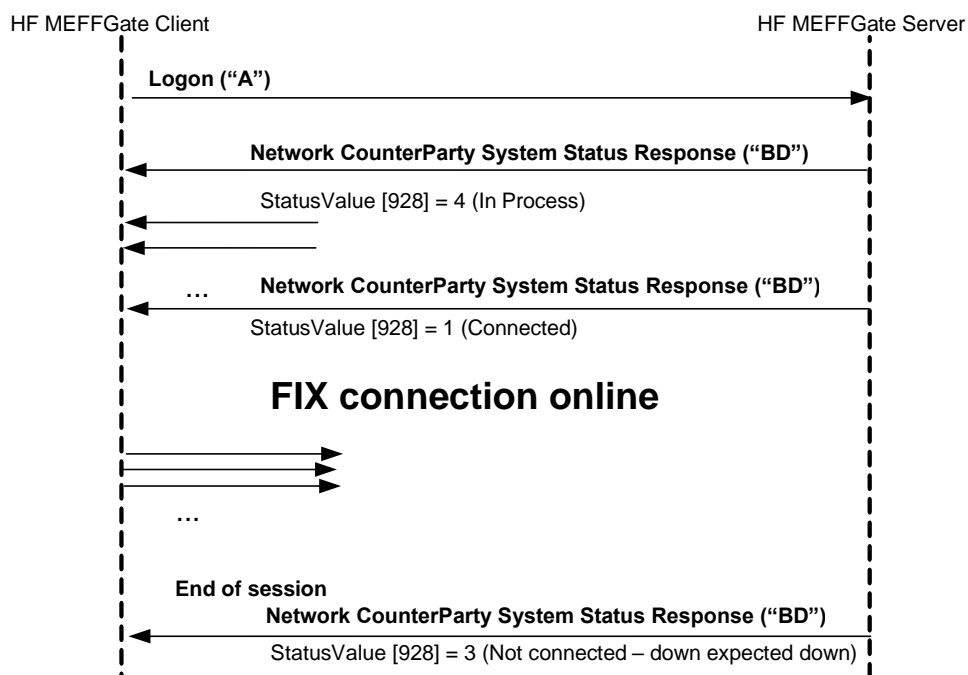

Individual password change

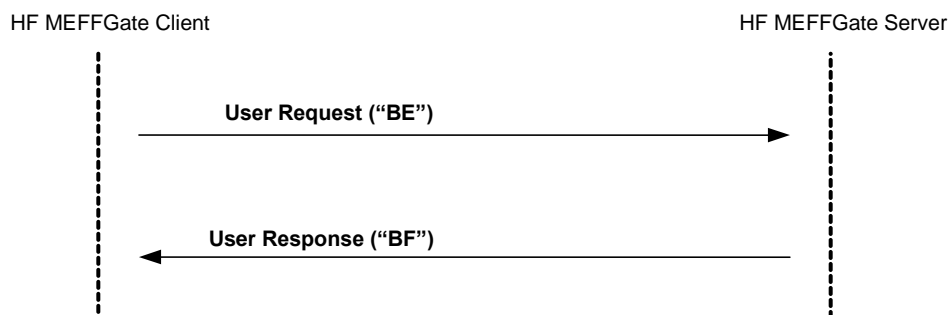

5.7 Annotations and adaptations of FIX 5.0

In the User Request message, the Password [554] and NewPassword [925] fields are now required.

5.8 Definition of messages

5.8.1 Network Counterparty System Status Request (Msg Type = BC)

Message sent by the client application to request information on the status of the connection between HF MEFFGate and the MEFF central systems.

Tag	Name	Req	Valid values	Format	Description
	Standard Header	Y	MsgType = BC		
935	NetworkRequestType	Y	2 = Subscribe	Int	
933	NetworkRequestID	Y		String(10)	Message identifier
	Standard Trailer	Y			

5.8.2 Network Counterparty System Status Response (Msg Type = BD)

Message sent by HF MEFFGate as reply to a Network Counterparty System Status Request Message.

It has information about the connectivity between HF MEFFGate and the MEFF central systems.

Tag	Name	Req	Valid values	Format	Description
	Standard Header	Y	MsgType = BD		
937	NetworkStatusResponseType	Y	1 = Full	Int	
933	NetworkRequestID	Y		String	Message identifier Network Counterparty System Status Request to which it is being responded
932	NetworkResponseID	Y		String	Unique message identifier
936	NoCompIDs	Y	1	NumInGroup	
→930	RefCompID	N		String	Contains the same value as the SenderCompID field in the header (see 3.3) This field is always included in the message
→931	RefSubID	N	See table 17 of document "Codification Tables"	String	Contains the same value as the SenderSubID field in the header (see 3.3) This field is always included in the message
→928	StatusValue	N	1 = Connected 2 = Not connected - down expected up 3 = Not connected - down expected down 4 = In Process	Int	Connection status This field is always included in the message
→929	StatusText	N		String	Additional information
	Standard Trailer	Y			

5.8.3 User Request (Msg Type = BE)

Message sent by the client to modify the password used in their connection to the HF MEFFGate

Tag	Name	Req	Valid values	Format	Description
	Standard Header	Y	MsgType = BE		
923	UserRequestID	Y		String (10)	Unique identifier for each User Request message
924	UserRequestType	Y	3 = Change Password For User	Int	
553	Username	Y		String	Identifier of the user assigned by MEFF. It is currently comprised of the combination of the member code and the user code
554	Password	Y*		String (10)	Old Password
925	NewPassword	Y*		String (10)	New Password
	Standard Trailer	Y			

5.8.4 User Response (Msg Type = BF)

Message sent by HF MEFFGate to notify the status of the request initiated with the User Request message.

This message is only sent to the user who made the request.

Tag	Name	Req	Valid values	Format	Description
	Standard Header	Y	MsgType = BF		
923	UserRequestID	Y		String	Identifier assigned by the client in the User Request message
553	Username	Y		String	User identifier
					Status of the User Request message
926	UserStatus	N	5 = Password Changed 6 = Other	Int	If rejected (value 6) , there is an explanation in the UserStatusText field
927	UserStatusText	N		String	When UserStatus = 6 there is an explanation of the rejection
	Standard Trailer	Y			

5.8.5 Business Message Reject (MsgType = j)

Message sent by HF MEFFGate when it receives a supported message that is syntactically correct in an unsupported situation, and there is no specific rejection message. It is especially used to reject a Network Counterparty System Status Request message.

Tag	Name	Req	Valid values	Format	Description
	Standard Header	Y	MsgType = j		
45	RefSeqNum	N		SeqNum	When present, indicates MsgSeqNum of the rejected message. If value zero, the content of this field should not be considered.
372	RefMsgType	Y	.	String	MsgType of the rejected message
379	BusinessRejectRefID	N		String	Optional Identifier of the rejected message
380	BusinessRejectReason	Y	0 = Other 3 = Unsupported Message Type	Int	Reason for rejection
58	Text	N		String	Explanation of rejection
	Standard Trailer	Y			

6 Indications of Interest

6.1 Introduction

The Indication of Interest functionality allows HF MEFFGate clients to enter and receive information about the indications of interest entered from its own member or through Market Services.

6.2 Description

When a trader wishes to indicate interest in prices being quoted on the order book of a contract, he should use the Indication of Interest message.

Only one Indication of Interest per contract per each FIX client is allowed.

When the client wants to modify an indication of interest on an specific security, it should cancel the existing indication of interest first and then send a new message.

To cancel an indication of interest, a message Indication of Interest with IOITransType[28]=C (Cancel) must be used.

The system automatically cancels the Quote Request after a certain time.

In the public feed, when an indication of interest has been entered, HF MEFFGate sends an Indication of Interest message to notify of this situation (see the public data interface of HF MEFFGate for more details). Each message refers to a single contract and indicates the accumulated volume of all existing indications of interest for the contract. Accordingly, each new message replaces any previous messages for the same contract.

When a trader requests the cancellation of their indication of interest, clients are notified of the remaining volume. If there is no remaining volume, clients receive a message showing zero volume.

All indications of interest are cancelled at the end of the trading session.

6.3 List of messages

Message	Description
Indication of Interest sent to HF MEFFGate (Msg Type = 6)	Message sent by the HF MEFFGate client to request or cancel an indication of interest on a specific contract
Business Message Reject (MsgType = j)	Message sent by HF MEFFGate to reject an Indication of Interest message
Indication of Interest sent by HF MEFFGate (Msg Type = 6)	Message sent by HF MEFFGate to answer an indication of interest in a contract

6.4 Message flow

Indication of Interest accepted by HF MEFFGate followed by its cancellation

(In this example, for illustrative purposes, public messages are grey shaded. These messages can be received from the public data interface of HF MEFFGate).

The client sends an indication of interest of 100x on contract A (having a total volume of indications of interest of 4900x). Once the request has been accepted, the client receives a private Indication of Interest (IOI), indicating that the 100x have been accepted and a public IOI message, with the accumulated volume of the indications of interest on this contract (5000x). Then the indication of interest is cancelled. Once the cancellation is accepted the accumulated volume of the remaining indication of interest on contract A is sent (4900x)

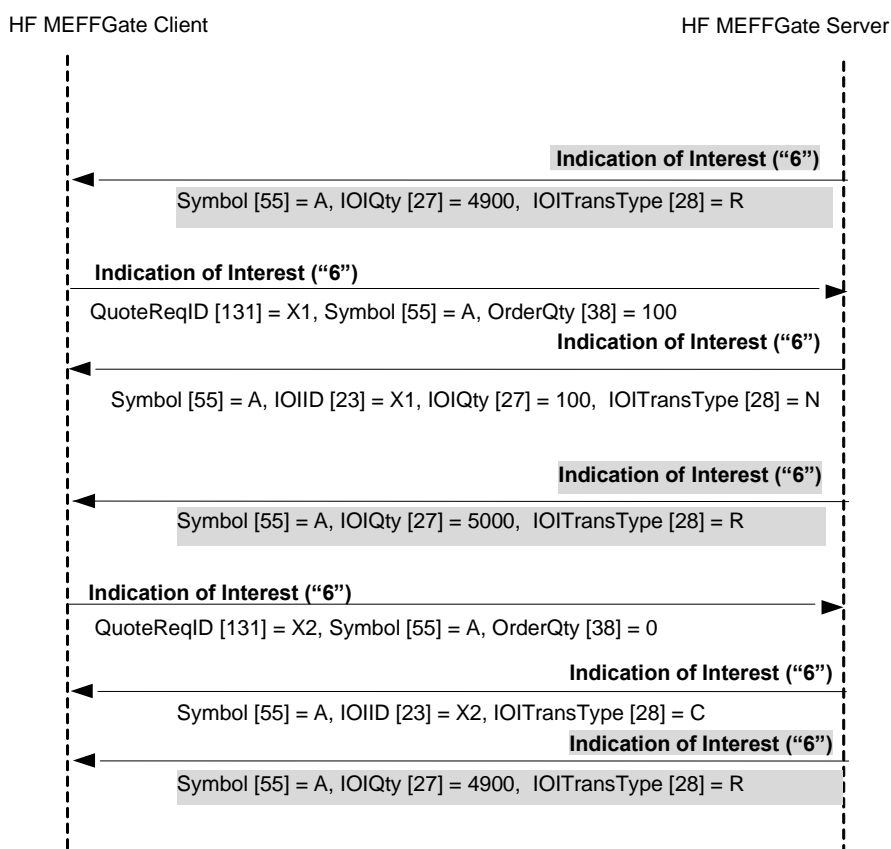

Indication of Interest rejected by HF MEFFGate

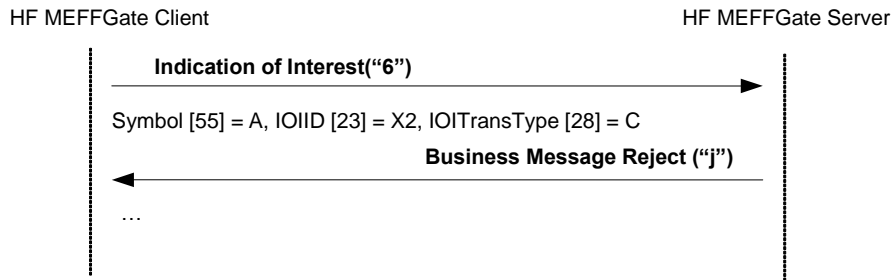

6.5 Annotations and adaptations of FIX 5.0

- None

6.6 Definition of messages

6.6.1 Indication of Interest sent to HF MEFFGate (Msg Type = 6)

Message sent by the HF MEFFGate client to request or cancel an indication of interest on a specific contract. Only one indication of interest can be sent in a single message

Tag	Name	Req	Valid values	Format	Description
	Standard Header	Y	MsgType = 6		
23	IOIID	Y		String	Identifier for this message
28	IOITransType	Y	N=New C=Cancel	Char	
	Start <Instrument>				
55	Symbol	Y		String (22)	Contract code
	End <Instrument>				
54	Side	Y	7=Undisclosed	Char	Indications of interest don't signal a specific Sell or Buy sign
27	IOIQty	Y	0-99999999 Integer numbers only	Qty	Volume of the request. Ignored if IOITransType[28]=C
	Standard Trailer	Y			

6.6.2 Indication of Interest sent by HF MEFFGate (Msg Type = 6)

Message sent by HF MEFFGate to notify an indication of interest on a specific contract.

Tag	Name	Req	Valid values	Format	Description
	Standard Header	Y	MsgType = 6		
1180	ApplID	N		String	Used in conjunction with ApplSeqNum [1181] to indicate, in subsequent connections, the point from which to receive information
1181	ApplSeqNum	N		SeqNum	Used in conjunction with ApplID [1180] to indicate, in subsequent connections, the point from which to receive information
23	IOIID	Y		String	Identifier sent by client, QuoteReqID [131], in Quote Request message
28	IOITransType	Y	N = New C = Cancel	Char	N = New Request C = Cancellation of Request
	Start <Instrument>				
55	Symbol	Y	Contract code	String(22)	Contract code
48	SecurityID	N		String(12)	ISIN security code
22	SecurityIDSource	N	4 = ISIN Number	String	
	End <Instrument>				
	Start <Parties>				
453	NoPartyIDs	N		NumInGroup	
→ 448	PartyID	N		String	See section 4.3 - Parties block
→ 447	PartyIDSource	N	D = Proprietary/ Custom code	Char	
→ 452	PartyRole	N	13 = Order Origination Firm 11 = Order Origination Trader	Int	Indicates the role taken by the code specified in PartyID
	End <Parties>				
54	Side	Y	7 = Undisclosed	Char	The indications of interest only define the contract and the volume but not if it is to buy or sell
27	IOIQty	Y	0 – 999999999, integer numbers only.	String	Volume of the request. Ignored if IOITransType[28]=C
60	TransactTime	N		UTCTimeStamp	Event time
	Standard Trailer	Y			

7 Order management and trades notification

7.1 Introduction

Order management covers various functions. From the perspective of a FIX client these are:

- Enter orders
- Modify orders
- Cancel orders
- Mass cancellation of orders
- Notification of order execution and information of trades

There is a separate section on each of these functions in this chapter. There is a description of the method of use, the list of related messages, the message flow and the additions or annotations incorporated in this implementation for each function. At the end of the chapter there is a detailed description of all the messages included in the chapter.

All the information provided in this chapter is valid for both single contracts and time-spreads, as time-spread orders are made on a previously defined contract (as opposed to the contracts that they are made up of).

7.2 Order management on behalf of a trader

HF MEFFGate offers the possibility, from a privileged multi-trader user, to enter and manage orders on behalf of another trader of the member.

7.3 Enter orders

7.3.1 Description

The FIX client uses this function to enter orders in the trading system.

Once an order has been accepted, it can be modified, cancelled or executed. These subjects are covered in detail in other sections of this chapter.

In the MEFF trading system each order is associated with an account. The FIX client usually indicates the account in the Account field. If the account is not specified when a new order is entered, the order will be assigned to the daily account. If a client does not have an daily account set up, an order without the account will be rejected. The account of an order can be modified while the order is alive, as described in 7.4.

The reference for the order has a maximum length of 15 characters and must be introduced in the Text field.

There are various relevant fields for the identification of orders. More information can be found in section "4.1 - Order identification".

7.3.2 Order entry status

When the order request has been sent to HF MEFFGate it can be directly rejected by HF MEFFGate or the central systems, in which case an Execution Report message is received where the field ExecType [150] = 8 (Rejected).

Based on an optimistic model, the client application can send modifications or cancellations for an order before receiving the Execution Report message with ExecType [150] = 0 (New).

When the request has been accepted by the central system, the client application will receive an Execution Report message with the field ExecType [150] = 0 (New). At this moment it can be considered that the order is active in the market.

If a situation arises that causes the order to be rejected by the central systems, an Execution Report message will be received with the field ExecType [150] = 0 (New), but in this case it will be followed by an Execution Report message with the field ExecType [150] = 4 (Cancelled).

If the order entered is a Stop, when the Stop is triggered, MEFFGate sends a new Execution Report message with the field ExecType = L (Triggered) reflecting the situation of the order after the trigger.

7.3.3 Supported order types and validity of orders

When sending the order request, the order type is specified by the combination of the OrdType and TimeInForce fields. 'MEFF Order Types' chapter has a list of all order types supported in MEFF and the corresponding values of these two fields in each case.

Moreover, according to the data specified in the Security List message, the features of hidden volume may be used.

7.3.4 Order persistence on connection loss

When sending an order request, it can be established if, in the event of a disconnection, the central system will cancel the pending volume or not.

This functionality is only valid for certain order types, detailed in ‘MEFF Order Types’ chapter. This functionality is not allowed in an order entered through a privileged user.

When an order is automatically cancelled in the event of a disconnection, a cancellation Execution Report message is sent.

7.3.5 List of messages

Message	Description
New Order - Single (Msg Type = D)	Used by the client to enter a new order
Execution Report (Msg Type = 8)	Sent by MEFF to confirm or reject the order

7.3.6 Message flow

In the following diagrams the values next to “Execution Report” correspond to the ExecType [150] and OrdStatus [39] fields, respectively.

New order entry accepted by HF MEFFGate and central systems

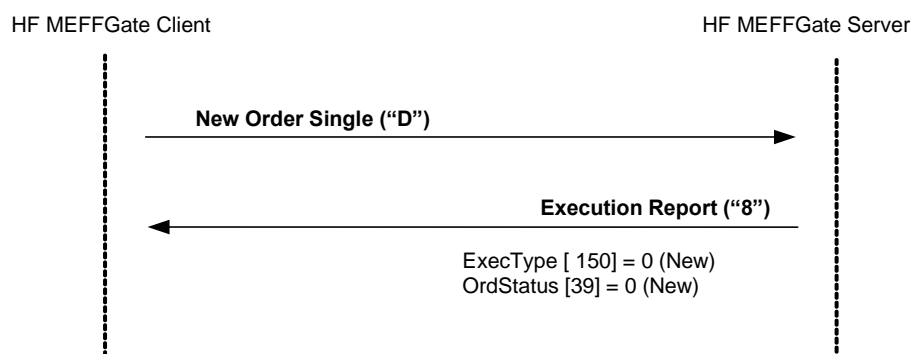

New order entry rejected by HF MEFFGate or central systems

When a new order message is directly rejected by HF MEFFGate, the client receives an Execution Report message with ExecType [150] = 8 (Rejected). The value of OrdStatus [39] is 8 (Rejected) except when the rejection occurs because the ClOrdID is duplicated, in which case this is notified in the order status corresponding to this ClOrdID.

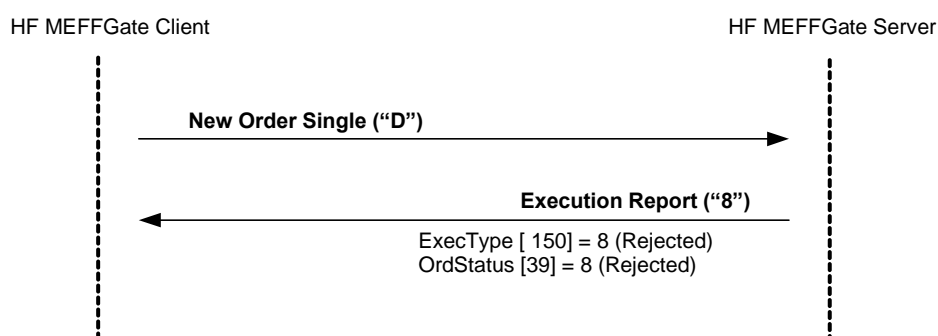

Entry of a stop order and triggering of the order

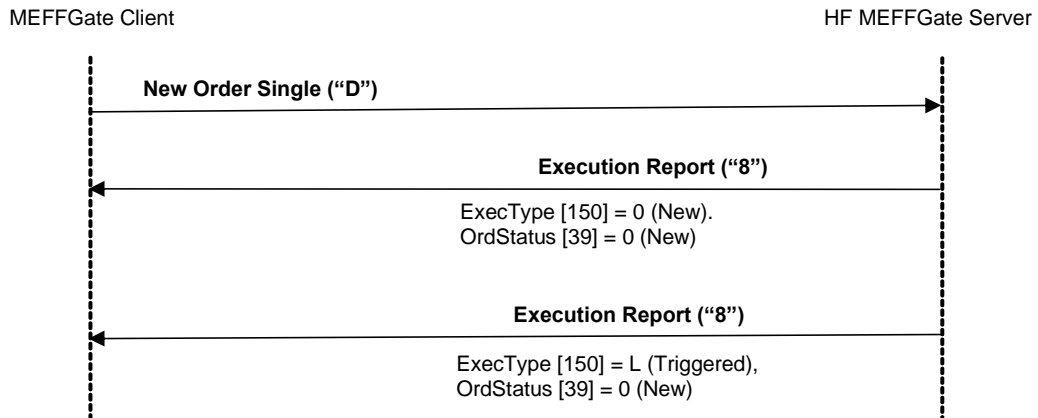

ReceivePendings [5678] (Logon) = Y: New order entry accepted by HF MEFFGate and central systems

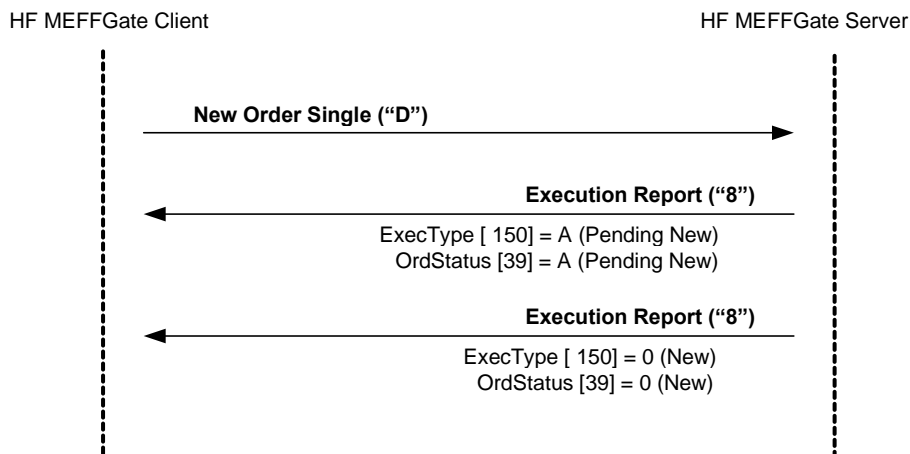

7.3.7 Annotations and adaptations of FIX 5.0

- In the New Order Single message, the OrderQty field is now required
- The fields FirmAllocText [1732], FirmMnemonic [1729], AllocText [161] and AlgorithmicTradeIndicator [2667] have been added to the New Order Single message

7.4 Modify orders

7.4.1 Description

When an order has been entered, but not fully executed it is possible to modify various attributes.

The following order attributes can be modified on MEFF:

- Account
- Volume
- Price
- Stop price
- Text (client order reference)
- Give-up reference
- Give-out internal reference
- Give-out mnemonic
- MiFID II tags:
 - Client identification (PartyRole [452] with value 3)
 - Party responsible for the investment decision within Firm (PartyRole [452] with value 122)
 - Party responsible for the Execution within Firm (PartyRole [452] with value 12)
 - DEA order flag (OrderOrigination [1724])
 - Liquidity provision flag (OrderAttributeType [2594] = 2 + OrderAttributeValue [2595] = "Y")
 - Trading capacity (LastCapacity [29])
 - Self-execution prevention (SelfMatchPreventionID [2362])
 - Algorithmic order flag (AlgorithmicTradeIndicator [2667])

Changes in any of these fields do not affect the volume previously filled.

The modification is made with the Order Cancel/Replace Request message, also called Order Modification Request.

Every modification message must specify a unique ClOrdID, just like the new order entry messages. The order to be modified is identified by the tag OrigClOrdID.

When a modification request is accepted and completed, the ClOrdID tag specified in the order modification request will become valid. Hence, the modified order replaces the original order through the use of this tag.

As a general rule, according to the FIX standard, all the application-level fields in the Order Modification Request should be retransmitted with the original values in the original order, except the fields that are being changed. Fields that are not specified implies will initialize it with the default value specified for the field.

Apart from the ClOrdID tag and the values to be modified, the FIX standard requires a number of redundant fields: Symbol (or ISIN code) and Side. These fields must be completed in the order modification request with the same values as the original order. If any of the values fail to match, the request is rejected with a Order Cancel Reject message with CxlRejReason = 2 (Broker/Exchange Option) and there is an explanation in the Text field.

The FIX standard also allows, as an optional feature, the volume of a fully filled order to be increased, effectively re-opening the order; this feature is not supported by MEFF.

The specifications of FIX 5.0 present a group of tables in the appendices to volume 4 that describe the message flows and the effects on the order status. Modification of the following tables is supported: C.1.a, C.1.b, C.2.a, C.3.a, C.3.b, C.3.c, D.1.a, D.1.b, D.1.c, D.2.a, D.2.b and D.2.d.

Table C.1.c is not supported.

7.4.2 Order modification request status

When an order modification request is sent to HF MEFFGate, it can be rejected directly by HF MEFFGate or the central systems, in which case an Order Cancel Reject message is received.

When the request has been accepted by the central system, the client application will receive an Execution Report message with the field ExecType [150] = 5 (Replaced), indicating that the modification has been done.

7.4.3 List of messages

Message	Description
Order Modification Request (Msg Type = G) (a.k.a. Order Cancel / Replace Request)	Used by the client to initiate order modification request
Execution Report (Msg Type = 8)	Sent by HF MEFFGate to notify status of modification request
Order Cancel Reject (Msg Type = 9)	Sent by HF MEFFGate to notify the rejection of order modification request

7.4.4 Message flow

The following diagrams show the values that appear in the the Execution Report in the ExecType [150] and OrdStatus [39] fields respectively. When OrdStatus [39] is shown as “<status>” it refers to the current status of the order, regardless of what its status is.

Order modification accepted by HF MEFFGate and central systems

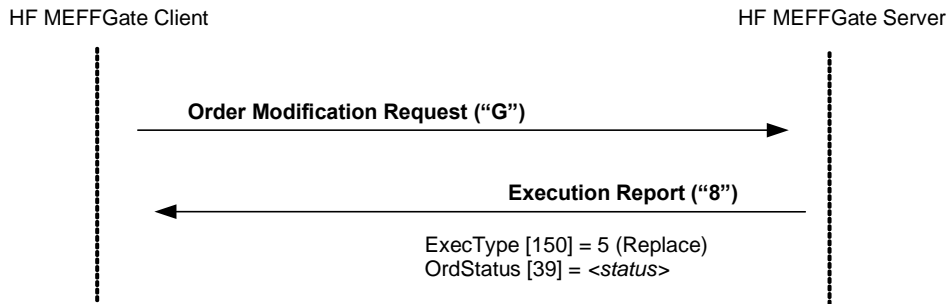

Order modification rejected by HF MEFFGate

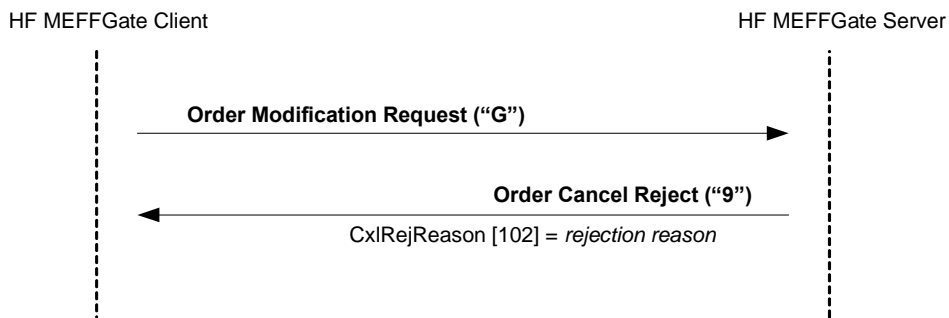

Modification request accepted by HF MEFFGate of an order executed in the moment it is requested

If the order to modify is executed in the intervening period between sending the modification request and its reception, the system will inform of said execution with an Execution Report message with ExecType [150] = F (Trade) and OrdStatus [39] = 2 (Filled). Also an Order Cancel Reject is sent by HF MEFFGate notifying the Order Modification Request has been rejected because the order execution on the fly.

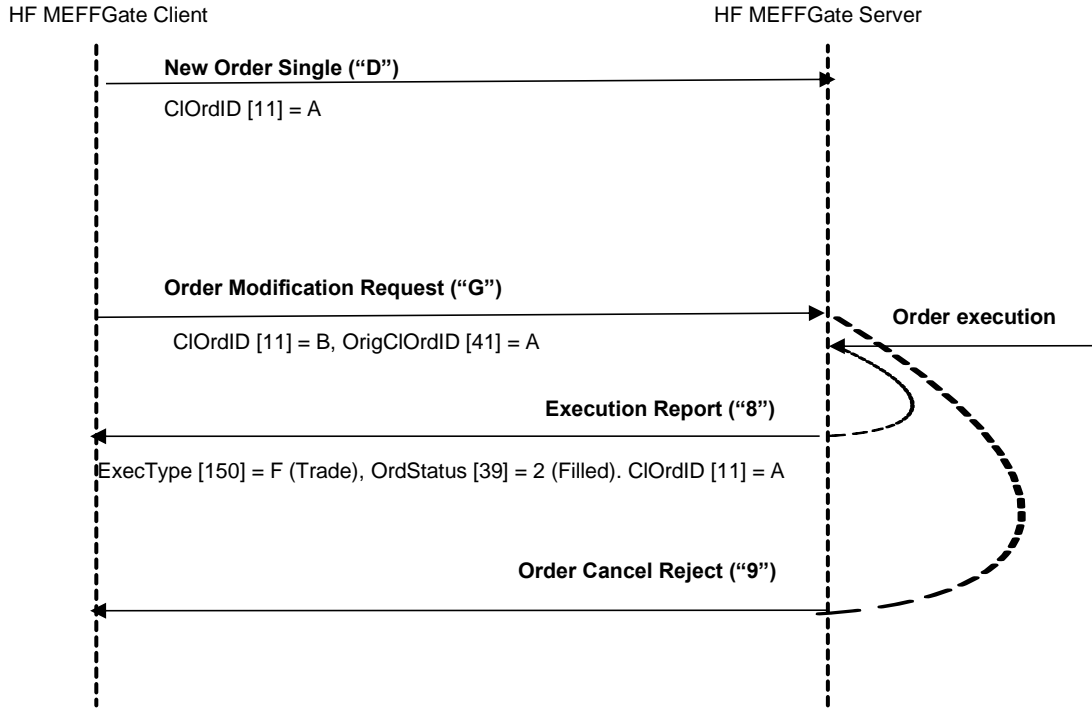

ReceivePendings [5678] (Logon) = Y: Order modification accepted by HF MEFFGate and central systems

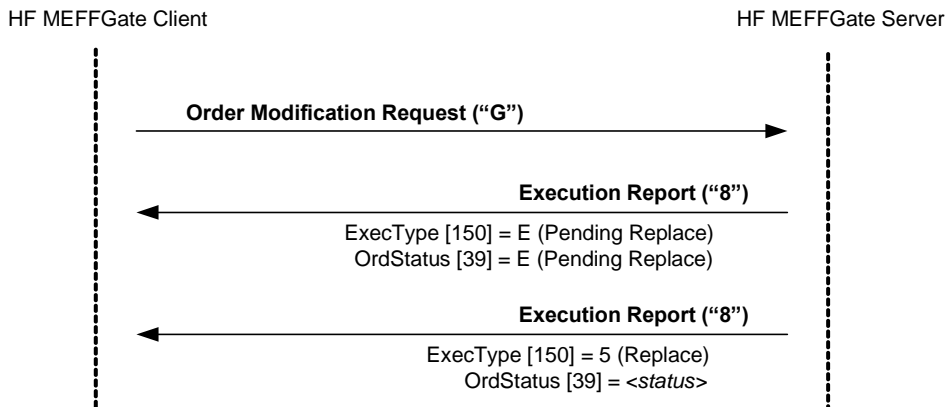

7.4.5 Annotations and adaptations of FIX 5.0

- In the Order Modification Request message, the OrderQty [38] field is now required
- The fields FirmAllocText [1732], FirmMnemonic [1729], AllocText [161] and AlgorithmicTradeIndicator [2667] have been added to the Order Modification Request message

7.5 Cancel orders

7.5.1 Description

Once an order has been entered, it can be cancelled at any time. The cancellation request is made with the Order Cancel Request message.

The Order Cancel Request message is used to cancel a specific order. The order to be cancelled is identified by the OrigClOrdID tag. In addition, the cancellation message must have a unique ClOrdID tag, just like the order entry and order modification messages.

The FIX standard requires certain redundant values to be included in the message: Symbol and Side. These fields must contain the same values as the order to be cancelled. If the values are not identical, the request will be rejected with the Order Cancel Reject message with the field CxlRejReason = 2 (Broker/Exchange Option) and an explanation in the Text field.

Note that the client does not have to wait for the order confirmation when it wants to cancel. In this case the client should use the ClOrdID of the pending request, assuming that it will be accepted.

7.5.2 Status of order cancellation request

When an order cancellation request is sent to HF MEFFGate, it can be rejected directly by HF MEFFGate or the central systems, in which case an Order Cancel Reject message is received.

After a request has been accepted by HF MEFFGate, and therefore sent to the central systems, one of the following situations will occur:

- **Cancellation of the order.** When the order is cancelled because of the request sent, an Execution Report message is received with ExecType [150] = 4 (Cancelled)
- **Cancellation of the order by Market Surveillance.** If a cancellation request, for the same order, sent by the MEFF Market Surveillance reaches the central systems before the own request, an Execution Report message will be received with ExecType [150] = 4 (Cancelled) due to the action of a third party. Also, an Order Cancel Reject is sent by HF MEFFGate notifying the Order Cancel Request has been rejected because the order is fully executed.
- **Execution of the order.** If the order to be cancelled is executed in the intervening period between sending the cancellation request and its reception, the system will inform of said execution with an Execution Report message with ExecType [150] = F (Trade) and OrdStatus [39] = 2 (Filled). Also, an Order Cancel Reject is sent by HF MEFFGate notifying the Order Cancel Request has been rejected because the order is fully executed.

When a cancellation is accepted and completed, the order is assigned the ClOrdID tag in the cancellation request message as its identifier.

7.5.3 List of messages

Message	Description
Order Cancel Request (Msg Type = F)	Used by the client to request the cancellation of an order
Execution Report (Msg Type = 8)	Sent by HF MEFFGate to notify status of cancellation
Order Cancel Reject (Msg Type = 9)	Sent by HF MEFFGate to notify rejection of cancellation request

7.5.4 Message flow

In the following diagrams, the values that appear after the "Execution Report" correspond to the ExecType [150] and OrdStatus [39] fields, respectively. When OrdStatus [39] is shown as "<status>" it refers to the current status of the order, regardless of its value.

Cancellation request accepted by HF MEFFGate and central systems

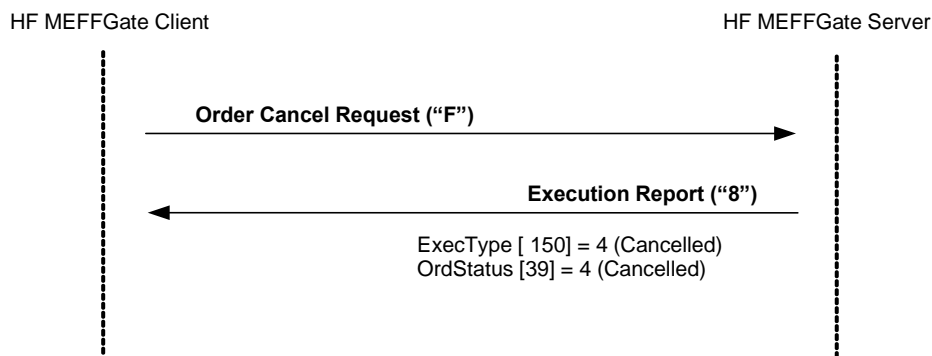

Cancellation of order before receiving a previous "Replace" status

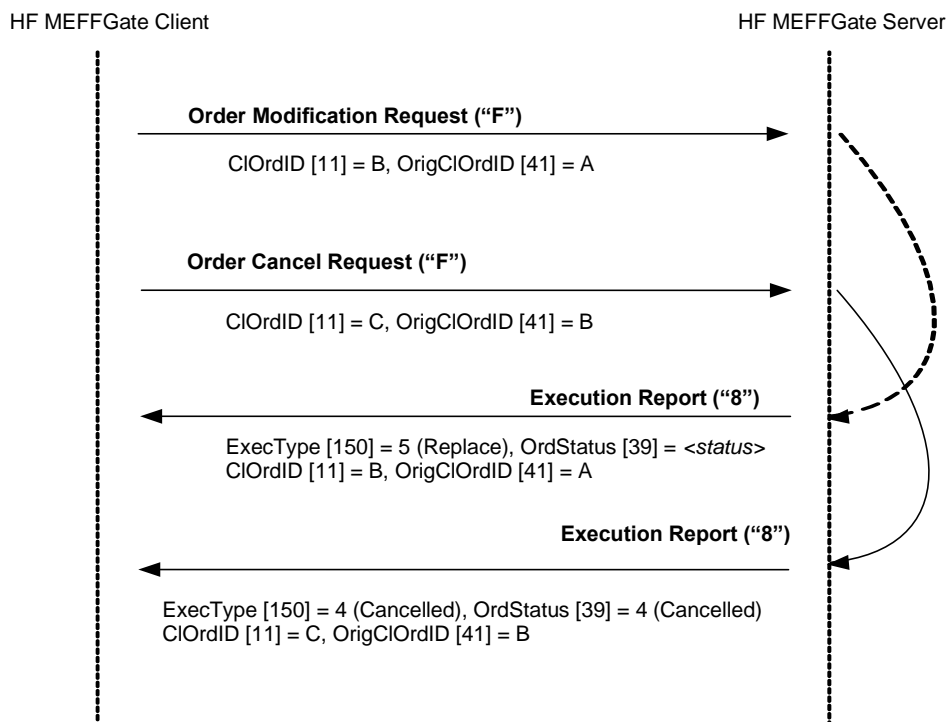

Cancellation request rejected by HF MEFFGate

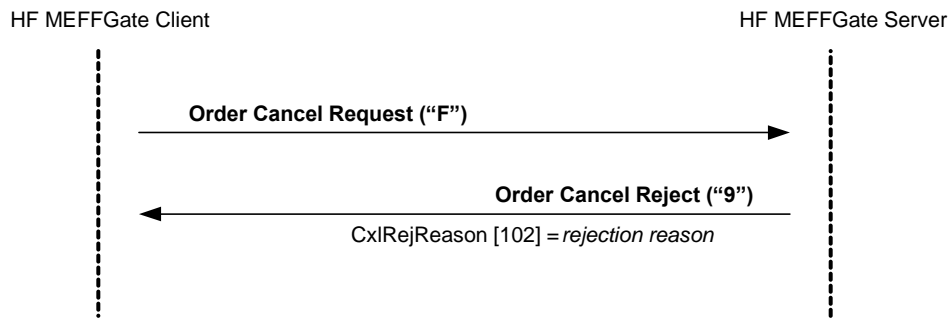

Cancellation request accepted by HF MEFFGate of an order executed in the moment it is requested

If the order to cancel is executed in the intervening period between sending the cancellation request and its reception, the system will inform of said execution with an Execution Report message with ExecType [150] = F (Trade) and OrdStatus [39] = 2 (Filled). Also, an Order Cancel Reject is sent by HF MEFFGate notifying the Order Cancel Request has been rejected because the order is fully executed.

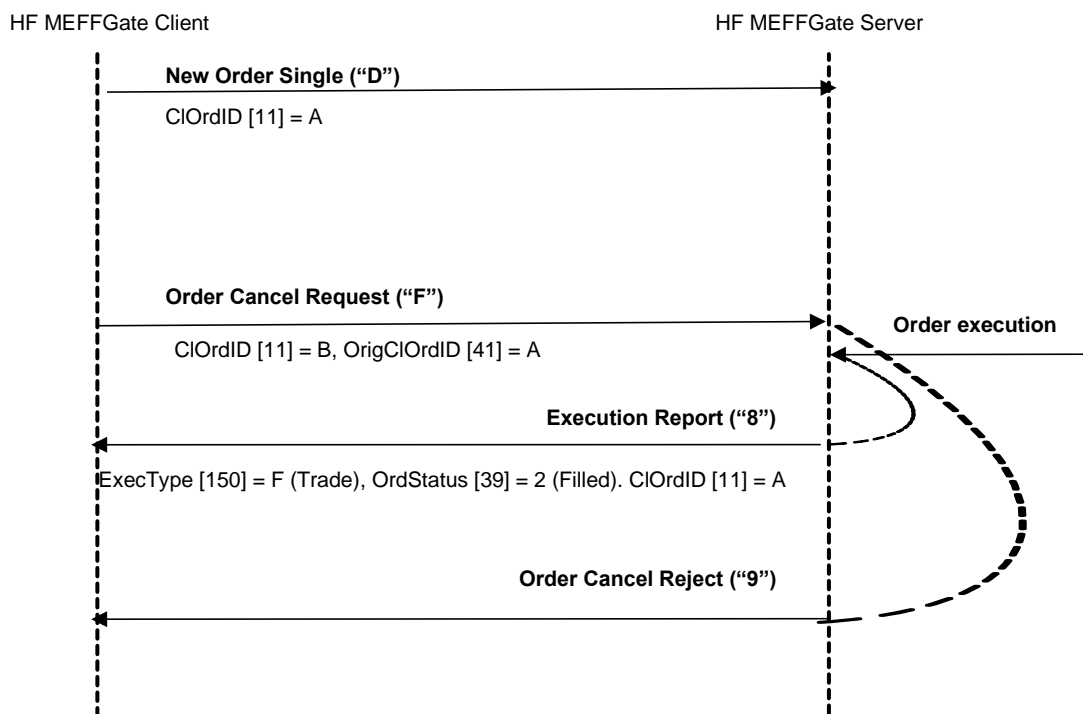

ReceivePendings [5678] (Logon) = Y: Cancellation request accepted by HF MEFFGate and central systems

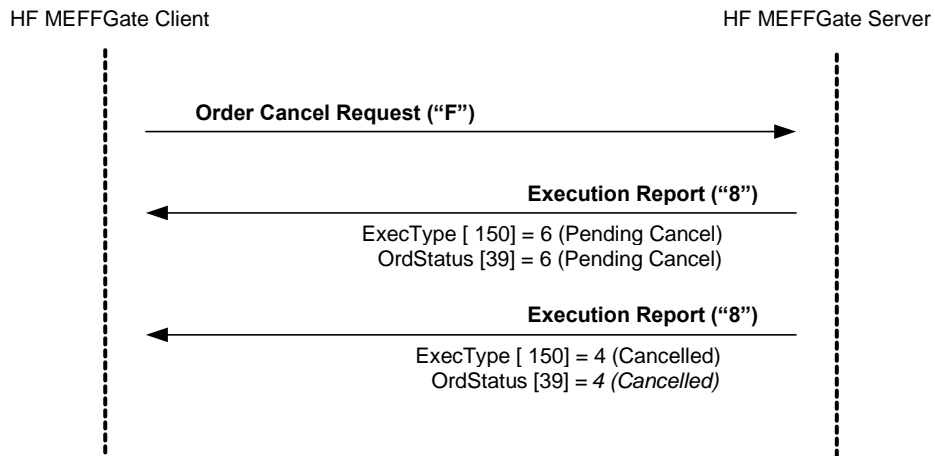

7.5.5 Annotations and adaptations of FIX 5.0

No annotations or adaptations have been made to the messages in this chapter

7.6 Mass cancellation of orders

7.6.1 Description

This function allows a group of orders to be cancelled simultaneously. The orders to be cancelled can be identified by specifying selection criteria. Please note that with this message, the pending quotes will not be cancelled.

7.6.2 Selection criteria

The selection criteria for orders to be cancelled provided by MEFF (using the Order Mass Cancel Request message) are the following:

- **Instrument.** Allows orders on a certain type of instrument to be selected using the Instrument block, as described in 4.4:
 - **Symbol [55]**
 - **SecurityType [167]**
 - **SecurityID [48]**
 - **MaturityMonthYear [200]**
- **Account.** Allows orders on a specific account or group of accounts to be selected. This selection is done using the Account field. The use of the wildcard “?” to make multiple selection is only allowed in the five positions at a time or in the last two positions. In the later case it must be used in both simultaneously
- **Buy/sell.** Allows buy orders and sell orders to be selected

When various criteria are used to make a selection, only the orders that meet all the criteria will be selected.

Selection criteria that are not used will be ignored when selecting orders. If no selection criteria are specified all orders will be included.

7.6.3 Status of mass cancellation request

Whether or not the mass cancellation is accepted or rejected, the server sends an Order Mass Cancel Report message. When the request is rejected, the MassCancelResponse field will be “0”. When it is accepted the value of the field will be “7”, even if there are no orders that meet the selection criteria.

The acceptance message should not be considered as confirmation of the cancellation. The server will send an Execution Report message for each of the orders cancelled.

7.6.4 ClOrdID field

In the corresponding Execution Report messages in which the cancellations are notified there is the OrigClOrdID field that identifies in an unique manner each of the cancelled orders.

Note that, in accordance with the standard, the ClOrdID field will contain the same value in all these messages, which corresponds with the ClOrdID that was assigned in the Order Mass Cancel Request message. Accordingly, it should be noted that from this moment on, the cancelled orders will all have the same ClOrdID.

More information on the ClOrdID field can be found in section 4.1.1.

7.6.5 List of messages

Message	Description
Order Mass Cancel Request (Msg Type = q)	Request to cancel orders that meet selection criteria
Order Mass Cancel Report (Msg Type = r)	Message sent by HF MEFFGate to confirm if mass cancellation is accepted or rejected. It is not used to confirm that cancellations have been processed
Execution Report (Msg Type = 8)	Message sent by HF MEFFGate to notify each individual cancellation due to the Order Mass Cancel Request message

7.6.6 Message flow

Mass cancellation order request accepted

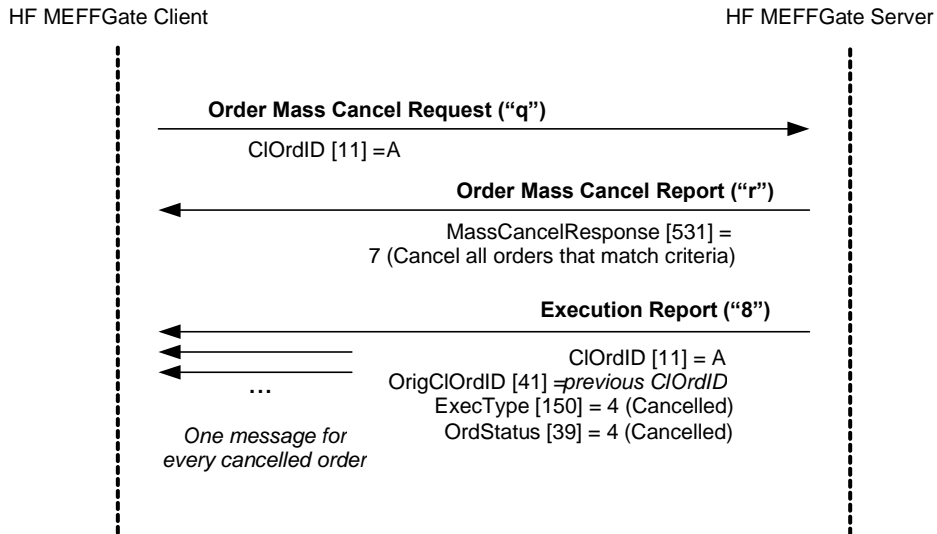

Mass order request rejected

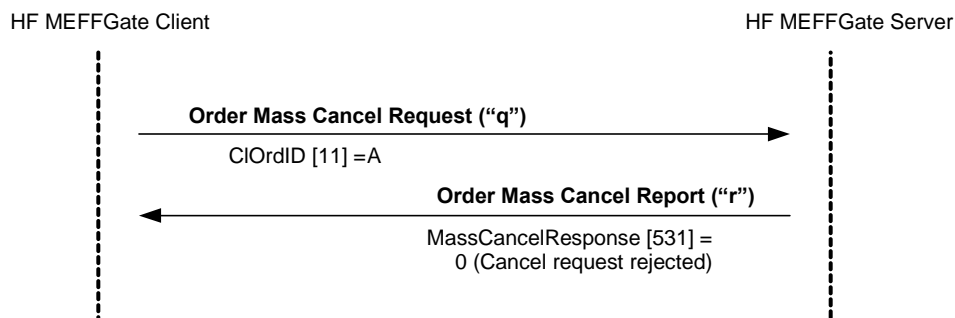

7.6.7 Annotations and adaptations of FIX 5.0

- The optional Account [1] field has been added to the Order Mass Cancel Request message
- The RejectText [1328] field has been added to the Order Mass Cancel Report message

7.7 Notification of execution

7.7.1 Description

When an order is filled or partially filled, HF MEFFGate sends an Execution Report message to notify this, where the field ExecType [150] = "F" (Trade).

When the Execution Report message is used to notify a trade, it specifies the type of trade in the TrdType [828] and TrdSubType [829] field. See table 19 in document "Codification Tables" for a list of possible values for this field and their descriptions.

In general terms, an Execution Report message will be received once a trade is accepted by the host, including the cross trades.

7.7.2 Trade cancellation / Trade amendment

When a trade is cancelled or amended, HF MEFFGate sends an Execution Report message with tag ExecType [150] = "H" (Trade Cancel) or "G" (Trade Correct). The ExecRefID [19] field contains the original trade registration number (TrdMatchID) of the cancelled trade or the amended trade.

7.7.3 List of messages

Message	Description
Execution Report (Msg Type = 8) (ExecType [150] = F)	Sent by HF MEFFGate to notify the order has been filled or partially filled

7.7.4 Message flow

Notification of execution

The client receives the Execution Report message for each partial fill or complete fill of an order.

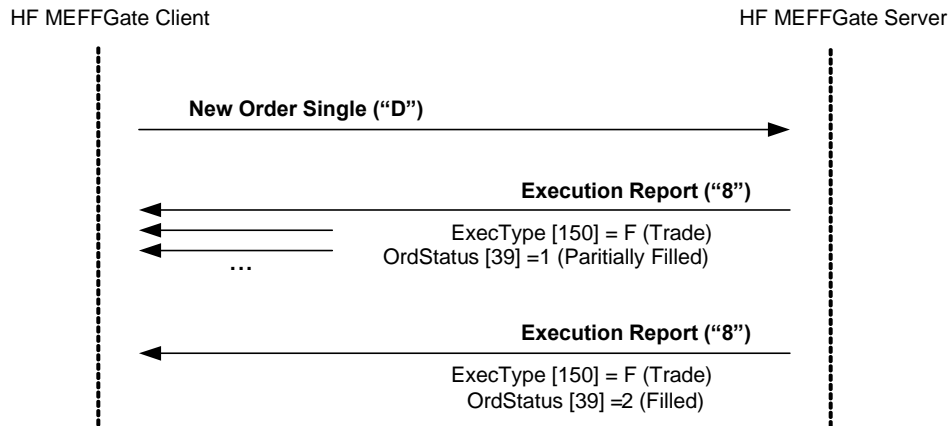

7.7.5 Annotations and adaptations of FIX 5.0

- The following fields: FirmAllocText [1732], FirmMnemonic [1729], AllocText [161], ClearingInstruction [577], RegulatoryReportType [1934], TradeCondition [277] and MarketID [1301] have been added to the Execution Report message

7.8 Order Status Request

7.8.1 Description

This section covers the functionality related to a query on a specific order to be checked using its ClOrdID

This function is limited to orders entered during the current trading session by the own trader.

The response is given as a single Execution Report message, showing the latest status of the order. If there is an error in the query, it is rejected with an Execution Report message with ExecType = 8 (Rejected).

The ClOrdID used will have to coincide with the last of the order. The query of a ClOrdID that has been replaced, through an order cancellation or modification, will be rejected with an Execution Report message with ExecType = 8 (Rejected).

Unlike the majority of order management messages, the ClOrdID field in the Order Status Request message must contain the reference for the order being consulted.

Note that the FIX standard for the order status request requires two redundant fields: Symbol and Side. The values for these fields must coincide with those in the original order.

7.8.2 List of messages

Message	Description
Order Status Request (Msg Type = H)	Status request for a specific order
Execution Report (Msg Type = 8)	Information on the order status, or notification of error in request

7.8.3 Message flow

Status request for a specific order

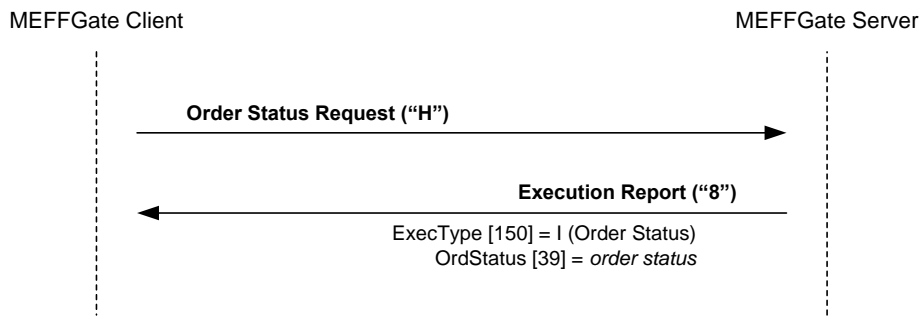

Status request for an unknown order, entered in a previous business session or not entered by the own trader

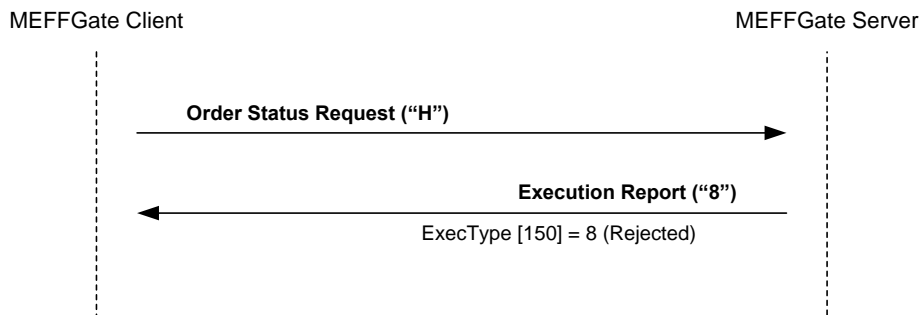

7.8.4 Annotations and adaptations of FIX 4.4

In the Order Status Request message, the `OrdStatusReqID [790]` field is now required

7.9 Definition of messages

7.9.1 New Order - Single (Msg Type = D)

Message sent by client to enter order in the system.

Tag	Name	Req	Valid values	Format	Description
	Standard Header	Y	MsgType = D		
11	ClOrdID	Y		String(30)	Unique order identifier
	Start <Parties>				
453	NoPartyIDs	N		NumInGroup	
→448	PartyID	N	For PartyRole [452] = 3, 12 or 122, this is an unsigned integer field, greater or equal than 0 and less than 2 ³²	String	See section 4.3 - Parties block For the Take-up Trading Firm (PartyRole = 96) the length for this tag is 4 characters
→447	PartyIDSource	N	D = Proprietary/ Custom code P = Short code identifier 3 = Client ID	Char	Required if NoPartyIDs is specified <ul style="list-style-type: none"> Value "P" for PartyRole [452] = 3, 12 or 122 Else value "D"
→452	PartyRole	N	11 = Order Origination Trader 12 = Execution within Firm ID 13 = Order Origination Firm 96 = Take-up Trading Firm 122 = Investment Decision within Firm ID	Int	Indicates the role taken by the code specified in PartyID [448]. Required if NoPartyIDs [453] is specified.
	End <Parties>				
1	Account	N	Fixed length	String(5)	Account code. If there is no account code the daily account is used
	Start <PreAllocGrp>				
78*	NoAllocs	N	1	NumInGroup	Number of destinations. HF MEFFGate only accepts a single destination. In this block the member who is entering the order, can also send all the necessary information to initiate an automatic give-up to the Clearing Broker once the trade is made and for the whole volume. This

Tag	Name	Req	Valid values	Format	Description
					information is: Give-up reference, give-out internal reference and Give-up mnemonic
→ 79*	AllocAccount	N	[N/A]	String	Always [N/A]
→ 1729*	FirmMnemonic	N		String (10)	Give-out mnemonic
→ 161*	AllocText	N		String (18)	Give-up reference
					Reference assigned by the Executing Broker for internal purposes.
→ 1732*	FirmAllocText	N		String (18)	It is associated to a Give-out mnemonic and it can be not unique. Need not be provided.
	End <PreAllocGrp>				
18	ExecInst	N	n = Not Cancel on connection loss (default) o = Cancel on connection loss	MultipleChar Value (ver 4.5)	It is used to indicate the action taken by the MEFF central system in the event of a disconnection. Value "o" means to cancel the pending volume. Not informing this tag or value "n" means the order will remain in the order book.
2362	SelfMatchPreventionID	N	Numeric, > 0, <= 999	String	Self-execution prevention
	Start <Instrument>				
55	Symbol	Y	Contract code	String(22)	Contract code
	End <Instrument>				
54	Side	Y	1 = Buy 2 = Sell	Char	
60	TransactTime	Y		UTC Timestamp	Time order request was made
	Start <OrderQtyData>				
38	OrderQty	Y*		Qty	Order volume
	End <OrderQtyData>				
40	OrdType	Y	See 'MEFF Order Types' chapter	Char	Order type
44	Price	N		Price	Order price
99	StopPx	N		Price	Stop price. Required if OrdType is 4
	Start <TriggeringInstruction>				
1100	TriggerType	N	4 = Price Movement	char	
			1 = Best Offer		Triggering Instruction for the Stop limit order.
1107	TriggerPriceType	N	2 = Last Trade 3 = Best Bid	char	If component block <TriggeringInstruction> is not

Tag	Name	Req	Valid values	Format	Description
			4 = Best Bid or Last Trade		specified when the order is sent, then the Stop limit order is triggered at Last Trade.
			5 = Best Offer or Last Trade		
			6 = Best Mid Bid-Offer		
	End <TriggeringInstruction>				
59	TimeInForce	N	See 'MEFF Order Types' chapter	Char	Indicates how long order is valid
432	ExpireDate	N		LocalMktDate	Date of order expiration (last day the order can trade). Required if TimeInForce [59] = GTD
58	Text	N		String(15)	Order reference given by client
77	PositionEffect	N	O=Open (default) C=Close	Char	Indicates whether the resulting position after a trade should be an opening position or closing position
1724	OrderOrigination	N	5 = Order received from a direct access or sponsored access customer	Int	DEA order flag
	Start <OrdAttrib>				
2593	NoOrderAttributes	N		NumInGroup	
→2594	OrderAttributeType	N	2	String	Liquidity provision flag
→2595	OrderAttributeValue	N	Y	String	Liquidity provision flag
	End <OrdAttrib>				
29	LastCapacity	N	1 = "AOTC" 3 = "MTCH" 4 = "DEAL"	Char	Trading capacity
2667*	AlgorithmicTradeIndicator	N	1 = Algorithmic (submitted by a trading algorithm)	Int	Algorithmic order flag
	Standard Trailer	Y			

7.9.2 Order Cancel Request (Msg Type = F)

Message sent by client to request cancellation of order.

Tag	Name	Req	Valid values	Format	Description
	Standard Header	Y	MsgType = F		
41	OrigCLOrdID	Y		String(30)	CLOrdID of order to cancel
11	CLOrdID	Y		String(30)	Cancellation identifier. It becomes the order identifier when the cancellation is processed
	Start <Parties>				
453	NoPartyIDs	N		NumInGroup	
→ 448	PartyID	N		String	See section 4.3 - Parties block
→ 447	PartyIDSource	N	D = Proprietary/ Custom code	Char	Required if NoPartyIDs is specified
→ 452	PartyRole	N	13 = Order Origination Firm 11 = Order Origination Trader	Int	Indicates the role taken by the code specified in PartyID. Required if NoPartyIDs is specified
	End <Parties>				
	Start <Instrument>				
55	Symbol	Y	Contract code	String(22)	Must contain the same value as specified in the original order
	End <Instrument>				
54	Side	Y	1 = Buy 2 = Sell	Char	Must contain the same value as specified in the original order
60	TransactTime	Y		UTC Timestamp	Time order request was made
	Standard Trailer	Y			

7.9.3 Order Modification Request (Msg Type = G)

(This message is also known as Order Cancel/Replace Request)

Message used to request order modification.

Tag	Name	Req	Valid values	Format	Description
	Standard Header	Y	MsgType = G		
	Start <Parties>				If it's being unchanged, must contain the same information as in the original order
453	NoPartyIDs	N		NumInGroup	
→ 448	PartyID	N	For PartyRole [452] = 3, 12 or 122, this is an unsigned integer field, greater or equal than 0 and less than 2 ³²	String	See section 4.3 - Parties block For the Give-Up Clearing Firm (PartyRole = 96) the length for this tag is 4 characters.
→ 447	PartyIDSource	N	D = Proprietary/ Custom code P = Short code identifier 3 = Client ID 11 = Order Origination Trader 12 = Execution within Firm ID 13 = Order Origination Firm 96 = Take-up Trading Firm 122 = Investment Decision within Firm ID	Char	Required if NoPartyIDs is specified <ul style="list-style-type: none"> Value "P" for PartyRole [452] = 3, 12 or 122 Else value "D"
→ 452	PartyRole	N		Int	Indicates the role taken by the code specified in PartyID [448]. Required if NoPartyIDs [453] is specified.
	End <Parties>				
41	OrigClOrdID	Y		String(30)	ClOrdID of order to substitute
11	ClOrdID	Y		String(30)	Modification identifier. It becomes the order identifier when the modification is made
1	Account	N	Fixed length	String(5)	New account code. If it's being unchanged, must contain the same value

Tag	Name	Req	Valid values	Format	Description
					as in the original order.
					If not specified, the daily account is used.
	Start <PreAllocGrp>				
					Number of destinations. HF MEFFGate only accepts a single destination.
					In this block the member who is entering the order, can also send all the necessary information to initiate an automatic give-up to the Clearing Broker once the trade is made and for the whole volume. This information is: Give-up reference, give-out internal reference and Give-up mnemonic
78*	NoAllocs	N	1	NumInGroup	
					If not specified, HF MEFFGate will delete (if it exists) this information block from the original order.
					If specified then it is necessary to inform the whole information for this block.
→ 79*	AllocAccount	N	[N/A]	String	Always [N/A]
→ 1729*	FirmMnemonic	N		String (10)	Give-out mnemonic
→ 161*	AllocText	N		String (18)	Give-up reference
					Reference assigned by the Executing Broker for internal purposes.
→ 1732*	FirmAllocText	N		String (18)	It is associated to a Give-out mnemonic and it can be not unique. Need not be provided.
	End <PreAllocGrp>				
					Self-execution prevention
2362	SelfMatchPreventionID	N	Numeric, > 0, <= 999	String	If it's being unchanged, must contain the same value as in the original order
	Start <Instrument>				
→55	Symbol	Y	Contract code	String(22)	Must contain the same value as in the original order
	End <Instrument>				
54	Side	Y	1 = Buy	Char	Must contain the same value

Tag	Name	Req	Valid values	Format	Description
			2 = Sell		as in the original order
60	TransactTime	Y		UTC Timestamp	Time order request was made
	Start <OrderQtyData>				
→38	OrderQty	Y*		Qty	New total intended Order Quantity (including the amount already executed for this chain of orders). For example, if the original order were of 20 securities, a partial execution of 5 securities took place, and the original order is wanted to reduce it in 1, this field should be accomplished with value 19.
	If it's being unchanged, must contain the same value as in the original order				
	End <OrderQtyData>				
40	OrdType	Y	See 'MEFF Order Types' chapter	Char	Must contain the same value as in the original order.
	New Order price.				
44	Price	N		Price	If it's being unchanged, must contain the same value as in the original order.
	New Stop price. Only allowed when OrdType = 4				
99	StopPx	N		Price	If it's being unchanged, must contain the same value as in the original order.
	Start <TriggeringInstruction>				
1100	TriggerType	N	4 = Price Movement 1 = Best Offer 2 = Last Trade 3 = Best Bid	char	Must contain the same value as in the original order.
	Triggering Instruction for the Stop limit order.				
1107	TriggerPriceType	N	4 = Best Bid or Last Trade 5 = Best Offer or Last Trade 6 = Best Mid Bid-Offer	char	If it's being unchanged, must contain the same value as in the original order.
	End				

Tag	Name	Req	Valid values	Format	Description
	<TriggeringInstruction>				
59	TimeInForce	N	See 'MEFF Order Types' chapter	Char	Must contain the same value as in the original order
432	ExpireDate	N		LocalMktDate	New date of order expiration (last day the order can trade). Only allowed when TimeInForce [59] = GTD. If it's being unchanged, must contain the same value as in the original order.
58	Text	N		String(15)	New order reference given by client. If it's being unchanged, must contain the same value as in the original order. If not specified, HF MEFFGate will initialize it with an empty string.
1724	OrderOrigination	N	5 = Order received from a direct access or sponsored access customer	Int	DEA order flag If it's being unchanged, must contain the same value as in the original order
	Start <OrdAttrib>				
2593	NoOrderAttributes	N		NumInGroup	Liquidity provision flag
→2594	OrderAttributeType	N	2	String	If it's being unchanged, must contain the same value as in the original order Liquidity provision flag
→2595	OrderAttributeValue	N	Y	String	If it's being unchanged, must contain the same value as in the original order
	End <OrdAttrib>				
29	LastCapacity	N	1 = "AOTC" 3 = "MTCH" 4 = "DEAL"	Char	Trading capacity
2667*	AlgorithmicTradeIndicator	N	1 = Algorithmic (submitted by a trading algorithm)	Int	Algorithmic order flag If it's being unchanged, must contain the same value as in the original order
	Standard Trailer	Y			

7.9.4 Execution Report (Msg Type = 8)

Message sent by HF MEFFGate to notify the status of an order, including if the order is filled or partially filled; also used to reject an invalid order request.

All the trades, including the cross trades, are informed with an Execution Report message where the field ExecType [150] = "F" (Trade).

Tag	Name	Req	Valid values	Format	Description
	Standard Header	Y	MsgType = 8		
1180	ApplID	N		String	Used in conjunction with ApplSeqNum [1181] to indicate, in subsequent connections, the point from which to receive information
1181	ApplSeqNum	N		SeqNum	Used in conjunction with ApplID [1180] to indicate, in subsequent connections, the point from which to receive information
37	OrderID	Y		String	Unique order identifier, assigned by HF MEFFGate or QuoteID sent by client in a quote. When ExecType [150] = 8 (Rejected), H (Trade Cancel), G (Trade Correct), E (Pending Replace) or 6 (Pending Cancel) it contains "NONE"
198	SecondaryOrderID	N		String	Order identifier, assigned by central system of MEFF or another exchange
527	SecondaryExecID	N		String	Order history number, assigned by central system of MEFF or another exchange. Each time there is a new event in the life of the order (modification, trade or cancellation) is assigned a new value to this field.
11	ClOrdID	N		String	ClOrdID (see 4.1.1) sent by client. Only included if this message is related to an order
41	OrigClOrdID	N		String(30)	OrigClOrdID sent by client. Only provided when the related message is a cancellation or modification request
790	OrdStatusReqID	N		String	It contains the same value as specified in the related Order Status Request. Only filled if the Execution Report is a consequence of an Order Status Request.
	Start <Parties>				
453	NoPartyIDs	N		NumInGroup	
→448	PartyID	N		String	See section 4.3 - Parties block
→447	PartyIDSource	N	D = Proprietary/ Custom code	Char	<ul style="list-style-type: none"> Value "P" for PartyRole [452] = 3, 12 or 122 Else value "D"

Tag	Name	Req	Valid values	Format	Description
			P = Short code identifier		
			1 = Executing Firm		
			3 = Client ID		
			7 = Entering Firm (intermediary)		
			11 = Order Origination Trader		
			12 = Execution within Firm ID		
→452	PartyRole	N	13 = Order Origination Firm	Int	Indicates the role taken by the code specified in PartyID.
			36 = Entering Trader (intermediary)		
			59 = Executing Trader		
			96 = Take-up Trading Firm		
			122 = Investment Decision within Firm ID		
End <Parties>					
548	CrossID	N		String	For cross trades contains the value of the field SecondaryTradeReportID [818] in the Trade Capture Report message.
					For RFQ contains the value of the field QuoteID [117] (Conversation ID) in the Quote Response message.
880	TrdMatchID	N		String	Trade registration number. Identifier of partial fill or filled order, assigned by central system of MEFF or another exchange.
					Provided when ExecType [150] = "F" (Trade), "H" (Trade Cancel) or "G" (Trade Correct).
17	ExecID	Y		String	Unique identifier of Execution Report assigned by HF MEFFGate
19	ExecRefID	N		String	Trade registration number (TrdMatchID) of the cancelled trade or amended trade.
					In leg trades It includes the trade registration number of the strategy

Tag	Name	Req	Valid values	Format	Description
			0 = New		
			4 = Cancelled		
			5 = Replace		
			6 = Pending Cancel		
			8 = Rejected		
			A = Pending New		Indicates the status of the associated message, whereas OrdStatus [39] provides the current order status.
150	ExecType	Y	C = Expired	Char	If cancelled (value 4) or rejected (value 8), there is an explanation in the RejectText [1328] field.
			D = Restated		
			E = Pending Replace		
			F = Trade		
			G = Trade Correct		
			H = Trade Cancel		
			I = Order Status		
			L = Triggered		
			0 = New		
			1 = Partially Filled		
			2 = Filled		
39	OrdStatus	Y	4 = Cancelled	Char	Indicates the current status of the order
			6 = Pending Cancel		
			8 = Rejected		
			A = Pending New		
			E = Pending Replace		
103	OrdRejReason	N	See codification table 11	Int	Rejection or cancellation motive. It can be provided when ExecType [150] = 4 or 8.
1328	RejectText	N		String	If ExecType [150] = 8 (Rejected) or 4 (Cancelled) there is an explanation of the rejection or cancellation
378	ExecRestatement Reason	N	1 = Renewal / Restatement	int	Code to identify reason for an ExecutionRpt message sent with ExecType [150] = D (Restated). Used for GTD orders at the start of the day.

Tag	Name	Req	Valid values	Format	Description
2667	AlgorithmicTradeIndicator	N	1 = Algorithmic (submitted by a trading algorithm)	Int	Algorithmic order flag
828	TrdType	N	See table 19 of document "Codification Tables" for details of the Trade Type codes	Int	Trade Type. Only provided when ExecType [150] = "F" (Trade), "H" (Trade Cancel) or "G" (Trade Correct). This value is used in conjunction with TrdSubType [829].
829	TrdSubType	N	See table 19 of document "Codification Tables" for details of the Trade Type codes	Int	This value is used in conjunction with TrdType [828]
1	Account	N	Fixed length	String(16)	Client account code
	Start <PreAllocGrp>				
78*	NoAllocs	N		NumInGroup	
→ 79*	AllocAccount	N	[N/A]	String	Always [N/A]
→ 1729*	FirmMnemonic	N		String (10)	Give-out mnemonic
→ 161*	AllocText	N		String (18)	Give-up reference
					Reference assigned by the Executing Broker for internal purposes.
→ 1732*	FirmAllocText	N		String (18)	It is associated to a Give-out mnemonic and it can be not unique. Need not be provided.
	End <PreAllocGrp>				
	Start <Instrument>				
55	Symbol	Y	Contract code	String(22)	Contract code associated with order
48	SecurityID	N		String(12)	ISIN security code
22	SecurityIDSource	N	4 = ISIN Number	String	
	End <Instrument>				
54	Side	Y	1 = Buy 2 = Sell	Char	
	Start <Stipulations>				
232	NoStipulations	N		NumInGroup	
			LATENCY = Indicator of having been in latency protection		
→ 233	StipulationType	N	MMTL31 = Level 3.1 - Transaction category MMT model	String	

Tag	Name	Req	Valid values	Format	Description
			PTF = Post-transparency flags		
			RTS24_21 = Event according to field 21 RTS 24		
					<p>When StipulationType [233] = LATENCY, the valid values are:</p> <ul style="list-style-type: none"> Y = Yes. The order, or the negotiation of the order or the negotiation of the quote side (buy or sell) has been in latency protection. N = No (default). The order, or the negotiation of the order or the negotiation of the quote side (buy or sell), has not been in latency protection. <p>If this field is not reported it means that the order, or the negotiation of the order or the negotiation of the quote side (buy or sell), has not been in latency protection.</p>
→ 234	StipulationValue	N		String	<p>When StipulationType [233] = MMTL31, it contains Level 3.1 - Transaction category MMT model:</p> <ul style="list-style-type: none"> Z = Package Trade (excluding Exchange for Physicals) "TPAC" Y = Exchange for Physicals Trade "XFPH" <p>When StipulationType [233] = PTF, it contains the trade post-transparency flags accordingly MiFID II directive. Different flags are enclosed by doubled quotes (") and separated by a comma</p> <p>When StipulationType=RTS24_21:</p> <ul style="list-style-type: none"> NEWO – New order REME – Replaced by initiative of message receiver REMA – Replaced by Market Surveillance (automatic) REMH – Replaced by Market Surveillance (manual) CAME – Cancellation by initiative of message receiver CAMO – Cancellation by Surveillance

Tag	Name	Req	Valid values	Format	Description
	End <Stipulations>				<ul style="list-style-type: none"> • REMO – Rejection • EXPI – Order expired • PARF – Partial fill • FILL – Filled • CHME – Change of status at the initiative of the member/participant of the trading venue • CHMO – Change of status due to market operations • TRIG – Order triggered
	Start <OrderQtyData>				
38	OrderQty	N		Qty	Total Order volume, as indicated in the New Order message, or in the modification message
	End <OrderQtyData>				
40	OrdType	N	See 'MEFF Order Types' chapter	Char	Order type
44	Price	N		Price	Order Price
99	StopPx	N		Price	Stop price of order
	Start <TriggeringInstruction>				
1100	TriggerType	N	4 = Price Movement 1 = Best Offer 2 = Last Trade 3 = Best Bid	char	Triggering Instruction for the Stop limit order.
1107	TriggerPriceType	N	4 = Best Bid or Last Trade 5 = Best Offer or Last Trade 6 = Best Mid Bid-Offer	char	If component block <TriggeringInstruction> is not specified then the Stop limit order is triggered at Last Trade.
	End <TriggeringInstruction>				
15	Currency	N		Currency	Currency code (3 character) values using ISO 3166
59	TimeInForce	N	See 'MEFF Order Types' chapter	Char	Indicates how long order is valid
432	ExpireDate	N		LocalMktDate	Date of order expiration (last day the order can trade)
18	ExecInst	N	n = Not Cancel on connection loss o = Cancel on	MultipleCharValue (ver 4.5)	Values "n" and "o" are used for the order persistence on connection loss.

Tag	Name	Req	Valid values	Format	Description
			connection loss		
1057	AggressorIndicator	N	Y = Order initiator is aggressor N = Order initiator is passive	Char	Passive/Aggressive Indicator
1390	TradePublishIndicator	N	1 = Immediate Publication 2 = Non-Immediate Publication	Int	Level 4.1 - Publication Mode / Post-Trade Deferral Reason MMT model (see also TrdRegPublicationType [2669] + TrdRegPublicationReason [2670])
32	LastQty	N		Qty	Volume on this fill. Provided if OrdStatus [39] = 1 or 2
31	LastPx	N		Price	Price of this fill. Provided if OrdStatus [39] = 1 or 2
			B = Continuous Auction "1"		
			Q = Quote Driven Market "2"		
			D = Dark Order Book "3"		
1430	VenueType	N	O = Off Book (including Voice or Messaging Trading) "4"	Char	Level 1 - Market Mechanism MMT model
			A = Periodic Auction "5"		
			N = Request for Quotes "6"		
1301*	MarketID	N	See table 33 document "Codification Tables"	Exchange	Operating MIC where the trade has been done according to ISO 10383
1300	MarketSegmentID	N	See table 33 document "Codification Tables"	String	Segment MIC where the trade has been done according to ISO 10383
			100 = IBEX futures hours		
			102 = Cross trades (IBEX futures hours)		
336	TradingSessionID	N	105 = Normal hours 106 = Delta and Basis Trade 107 = Bono hours	String	Trading mode. Provided if OrdStatus [39] = 1 or 2

Tag	Name	Req	Valid values	Format	Description
			108 = Cross trades (normal hours)		
			109 = Cross trades (Bono hours)		
			115 = RFQ (IBEX futures hours)		
			116 = RFQ (normal hours)		
			117 RFQ (Bono hours)		
			1 = "AOTC"		
29	LastCapacity	N	3 = "MTCH" 4 = "DEAL"	Char	Trading capacity
151	LeavesQty	Y		Qty	Order volume pending Contains 0 when OrdStatus [39] = 4 (Cancelled) or 6 (Pending Cancel) Total order volume filled
14	CumQty	Y		Qty	This field should not be considered when zero
60	TransactTime	N		UTCTimest amp	Time when transaction represented by this Execution Report occurred. Not present when ExecType [150] = 6, A or E
381	GrossTradeAmt	N		Amt	Effective amount of this trade. Present when ExecType [150] = "F" (Trade), "G" (Trade Correct) or "H" (Trade Cancel)
2362	SelfMatchPreventionID	N	Numeric, > 0, <= 999	String	Self-execution prevention
77	PositionEffect	N	O=Open C=Close	Char	Indicates whether the resulting position after a trade should be an opening position or closing position. Only applies to the omnibus accounts.
58	Text	N		String	It contains the client order reference, entered in the Text field of the order message
442	MultiLegReportingType	N	1=Single Security 2=Individual leg of a multi-leg security 3=Multi-leg security	Char	Indicates whether the trade refers to a single contract a time-spread or strategy, or the leg of a time spread or strategy.
1724	OrderOrigination	N	5 = Order received from a direct access or sponsored access customer	Int	DEA order flag
	Start				

Tag	Name	Req	Valid values	Format	Description
	<TrdRegTimestamps>				
768	NoTrdRegTimestamps	N		NumInGroup	
→769	TrdRegTimestamp	N		UTCTimestamp	<ul style="list-style-type: none"> • When TrdRegTimestampType [770] = 1, it contains the trade execution time • When TrdRegTimestampType [770] = 8, it contains the date and time every time the priority of the order changes • When TrdRegTimestampType [770] = 8, it contains the date at which the order has been accepted by the central system. Not present when ExecType [150] = 6, A or E • When TrdRegTimestampType [770] = 11, it contains the date and time publicly reported of the trade
			1 = Execution time		
			8 = Time priority		
→770	TrdRegTimestampType	N	9 = OrderBookEntryTime 11 = Publicly reported	Int	
	End <TrdRegTimestamps>				
	Start <OrdAttrib>				
2593	NoOrderAttributes	N		NumInGroup	
→2594	OrderAttributeType	N	2 = Liquidity provision flag 3 = Risk reduction order	String	
→2595	OrderAttributeValue	N		String	<ul style="list-style-type: none"> • When OrderAttributeType [2594] = 2, indicates a Liquidity provision activity order. Valid values: Y = In the context of ESMA RTS 24 Article 3, when OrderAttributeValue(2595)=Y, it signifies that the order was submitted "as part of a market making strategy pursuant to Articles 17 and 18 of Directive 2014/65/EU,

Tag	Name	Req	Valid values	Format	Description
	End <OrdAttrib>				or is submitted as part of another activity in accordance with Article 3" (of RTS 24)
	Start <TrdRegPublicationGrp>				<ul style="list-style-type: none"> When OrderAttributeType [2594] = 3, indicates a Risk reduction order. Valid values: Y = In the context of ESMA RTS 22 Article 4(2)(i), when OrderAttributeValue(2595)=Y, it signifies that the commodity derivative order is a transaction "to reduce risk in an objectively measurable way in accordance with Article 57 of Directive 2014/65/EU" N = The commodity derivative order does NOT reduce risk in an objectively measurable way in accordance with Article 57 of Directive 2014/65/EU"
2668	NoTrdRegPublications	N		NumInGroup	
→ 2669	TrdRegPublicationType	N	0 = Pre-trade transparency waiver 1 = Post-trade deferral	Int	Value 0: Level 3.2 - Negotiation Indicator or Pre-trade Transparency Waiver MMT model (see also TrdRegPublicationReason [2670]) Value 1: Level 4.1 - Publication Mode / Post-Trade Deferral Reason MMT model (see also TradePublishIndicator [1390] + TrdRegPublicationReason [2670])
					Maybe present if MDEntryType is 2
→ 2670	TrdRegPublicationReason	N	6 = Non-Immediate Publication: Deferral for "Large in Scale" "LRGS" 7 = Non-Immediate Publication: Deferral for "Illiquid Instrument" (RTS 2 only) "ILQD" 8 = Non-Immediate Publication: Deferral	Int	Values 6, 7 and 8: Level 4.1 - Publication Mode / Post-Trade Deferral Reason MMT model (related to TradePublishIndicator [1390] = 2 and TrdRegPublicationType [2669] = 1)

Tag	Name	Req	Valid values	Format	Description
			for "Size Specific" (RTS 2 only) "SIZE"		
	End <TrdRegPublicatio nGrp>				
	Start <TradePriceCondi tionGrp>				
1838	NoTradePriceCon ditions	N		NumInGro up	
→1839	TradePriceCondi tion	N	15 = Non-Price Forming Trade (formerly defined as a Technical Trade) "NPFT"	Int	Level 3.8 - Ordinary/Standard Trades or Trades Outside Price Formation / Discovery Process MMT model
	End <TradePriceCondi tionGrp>				
	Start <ClrInstrGrp>				
576*	NoClearingInstru ctions	N	1	NumInGro up	
→577*	ClearingInstructio n	N	6 = Trade for the ECC (Clear against central counterparty) 7 = Exclude from central counterparty	Int	Transaction to be cleared on a CCP
	End <ClrInstrGrp>				
			11 = Limited details trade "LMTF"		
			12 = Daily aggregated trade "DATF"		
			13 = Volume omission trade "VOLO"		
1934*	RegulatoryReport Type	N	14 = Four weeks aggregation trade "FWAF" 15 = Indefinite aggregation trade "IDAF" 16 = Volume omission trade. Eligible for subsequent enrichment in	Char	Level 4.2 - Post-Trade deferral or Enrichment MMT model

Tag	Name	Req	Valid values	Format	Description
			aggregated form "VOLW"		
277*	TradeCondition	N	6 = Benchmark Trade "BENC"	MultipleSt ringValue	Level 3.5 - Benchmark or Reference Price Indicator indicator MMT model
	Standard Trailer	Y			

7.9.5 Order Cancel Reject (Msg Type = 9)

Message sent by HF MEFFGate to reject an order modification or cancellation message.

Tag	Name	Req	Valid values	Format	Description
	Standard Header	Y	MsgType = 9		
37	OrderID	Y	See 4.1.2	String	OrderID associated to order. It is "NONE" if CxlRejReason = 1 (Unknown order)
	Start <Parties>				
453	NoPartyIDs	N		NumInGroup	
→ 448	PartyID	N		String	See section 4.3 - Parties block
→ 447	PartyIDSource	N	D = Proprietary/ Custom code	Char	Required if NoPartyIDs is specified
→ 452	PartyRole	N	13 = Order Origination Firm 11 = Order Origination Trader	Int	Indicates the role taken by the code specified in PartyID. Required if NoPartyIDs is specified
	End <Parties>				
11	ClOrdID	Y		String(30)	ClOrdID of rejected message
41	OrigClOrdID	Y		String(30)	ClOrdID of order that could not be modified or cancelled. Contains the same value as OrigClOrdID of the cancellation or modification request message
			0 = New		
			1 = Partially Filled		
			2 = Filled		
			4 = Cancelled		
			8 = Rejected		
			C = Expired		
39	OrdStatus	Y		Char	Order status. It is 8 (Rejected) if CxlRejReason = 1 (Unknown order)
60	TransactTime	N		UTC Timestamp	Time rejection message generated
			1 = Order Cancel Request		
434	CxlRejResponseTo	Y	2 = Order Cancel/Replace Request	Char	Type of message responded to
			0 = Too late to cancel		
			1 = Unknown order		
102	CxlRejReason	N	2 = Exchange option 3 = Order already in Pending Cancel or Pending Replace	Int	Rejection motive. If value is 99 there is an explanation in the RejectText [1328] field

Tag	Name	Req	Valid values	Format	Description
			status		
			6 = Duplicate CIOrdID received		
			99=other		
1328	RejectText	N		String	Explanation of rejection
	Standard Trailer	Y			

7.9.6 Order Status Request (Msg Type = H)

Message sent by the client to request information on the status of a specific order.

Tag	Name	Req	Valid values	Format	Description
	Standard Header	Y	MsgType = H		
11	ClOrdID	Y		String(30)	ClOrdID of the order for which status is required
790	OrdStatusReqID	Y*		String(10)	Message identifier
	Start <Instrument>				
55	Symbol	Y	Contract code	String(22)	Must contain the same value as the order queried
	End <Instrument>				
54	Side	Y	1 = Buy 2 = Sell	Char	Must contain the same value as the order queried
	Standard Trailer	Y			

7.9.7 Order Mass Cancel Request (Msg Type = q)

Message sent by the client to request the cancellation of orders that meet certain selection criteria.

Tag	Name	Req	Valid values	Format	Description
	Standard Header	Y	MsgType = q		
11	ClOrdID	Y		String(30)	Unique identifier of this Order Mass Cancel Request message
530	MassCancelRequestType	Y	7 = Cancel all orders that match criteria	Char	Cancel orders that meet the selection criteria
	Start <Parties>				
453	NoPartyIDs	N		NumInGroup	
→ 448	PartyID	N		String	See section 4.3 - Parties block
→ 447	PartyIDSource	N	D = Proprietary/ Custom code	Char	Required if NoPartyIDs is specified
→ 452	PartyRole	N	13 = Order Origination Firm 11 = Order Origination Trader	Int	Indicates the role of the code specified in PartyID. Required if NoPartyIDs is specified
	End <Parties>				
	Start <Instrument>				
55	Symbol	Y	[N/A] or contract code	String(22)	Contract code. If it is "[N/A]" the orders for all contracts matching the rest of criteria will be selected
48	SecurityID	N	See table 21 in document "Codification Tables" for a list of possible values	String	Underlying asset
22	SecurityIDSource	N	8 = Exchange Symbol	String	Required if SecurityID is specified
167	SecurityType	N	See table 31 of document "Codification Tables"	String	Product type
200	MaturityMonthYear	N	YYYYMM, YYYYMMDD or YYYYMMwW	Month-Year	Contract expiration
	End <Instrument>				
54	Side	N	1 = Buy 2 = Sell	Char	Selection criteria for buy or sell orders
60	TransactTime	Y		UTC Timestamp	Time order request was made
1*	Account	N	Fixed length	String(5)	Account code. The use of the wildcard "?" for multiple selection is only

Tag	Name	Req	Valid values	Format	Description
					permitted in the five positions at a time or in the last two positions. In the later case it must be used in both at the same time
	Standard Trailer	Y			

7.9.8 Order Mass Cancel Report (Msg Type = r)

Message responding to a mass order cancellation request. It notifies whether the request is accepted or rejected. To ensure that the cancellations have been processed, it is necessary to wait until the corresponding Execution Reports are received.

Tag	Name	Req	Valid values	Format	Description
	Standard Header	Y	MsgType = r		
1180	ApplID	N		String	Used in conjunction with ApplSeqNum [1181] to indicate, in subsequent connections, the point from which to receive information
1181	ApplSeqNum	N		SeqNum	Used in conjunction with ApplID [1180] to indicate, in subsequent connections, the point from which to receive information
11	ClOrdID	N		String(30)	ClOrdID specified in the Order Mass Cancel Request message
37	OrderID	Y		String	Unique identifier for the Order Mass Cancel Request message assigned by MEFF
530	MassCancelRequestType	Y	7	Char	Contains the same value as specified in request
531	MassCancelResponse	Y	0 = Cancel Request Rejected 7 = Cancel all orders that match criteria	Char	7 if the cancellation is accepted. 0 if rejected. If it is 0, the MassCancelRejectReason field gives the rejection motive
532	MassCancelRejectReason	N	1 = Invalid or unknown Security 99 = other	String	Rejection motive. Provided if MassCancelResponse = 0. If value is 99, there is an explanation of the rejection motive in the RejectText [1328] field
1328*	RejectText	N		String	Explanation of rejection motive
	Standard Trailer	Y			

8 Strategies

8.1 Introduction

Every strategy is defined by the FIX client through a Security Definition Request message. Leg contract code, which provides the identification of the legs, their ratios and side, are mandatory attributes of the request.

HF MEFFGate validates the user request and, if valid, creates a tradeable instrument that is sent to the FIX client through this private interface data via a Security Definition message and, also, disseminated to the whole market participants through the HF MEFFGate public interface data via a Security List Update Report message.

Once the strategy has been successfully created, it is possible to enter orders via a New-Order – Single message.

All strategies are cancelled at the end of the trading session. If, at the next trading session, the FIX client wishes to trade a new strategy, it should first define a new strategy in the same way explained above.

8.2 List of messages

Message	Description
Security Definition Request (Msg Type = c)	Message sent by the HF MEFFGate client to create a new strategy instrument
Security Definition (Msg Type = d)	Message sent by HF MEFFGate to accept or reject a Security Definition Request message

8.3 Message flow

Security Definition Request accepted by HF MEFFGate followed by a strategy order entry

(In this example, for illustrative purposes, public messages are gray shaded. These messages can be received from the public data interface of HF MEFFGate).

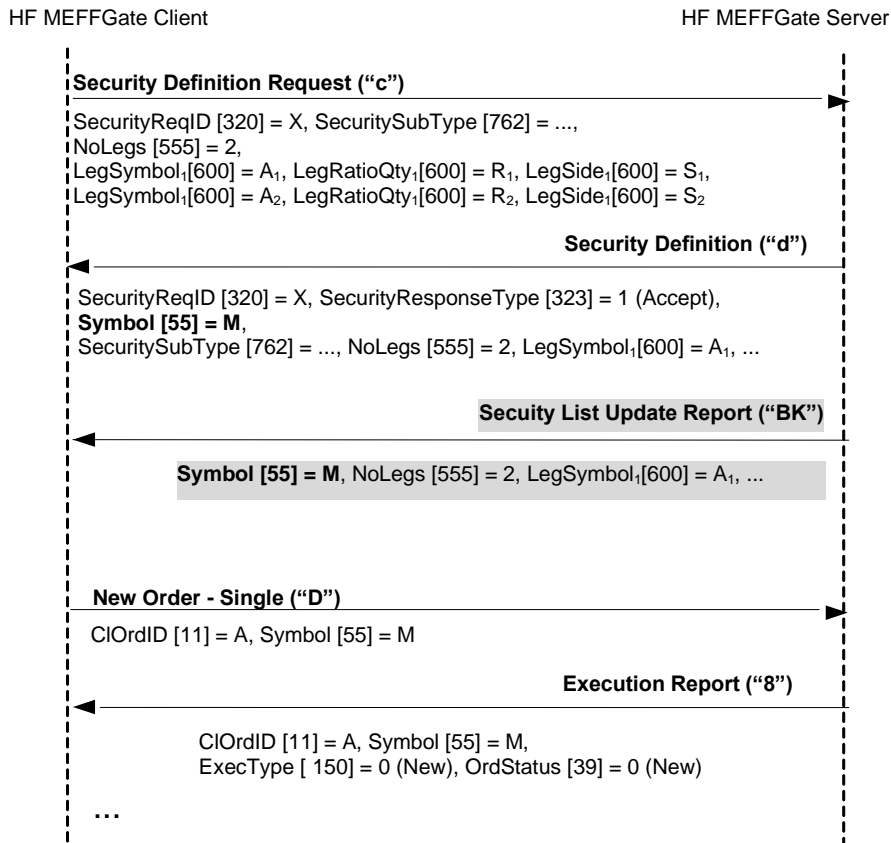

Security Definition Request rejected by HF MEFFGate

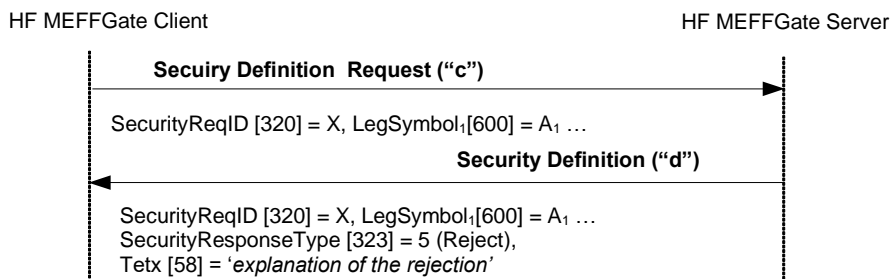

8.4 Annotations and adaptations of FIX 5.0

- In the Security Definition Request message, the SecurityID [48] and SecuritySubType [762] fields are now required

8.5 Definition of messages

8.5.1 Security Definition Request (Msg Type = c)

Message sent by the HF MEFFGate client to create a new strategy instrument

Tag	Name	Req	Valid values	Format	Description
	Standard Header	Y	MsgType = c		
320	SecurityReqID	Y		String (10)	Identifier for this Security Definition Request message
321	SecurityReqType	Y	1 = Request security identity for the specifications provided	String	Value must = 1
	Start <Instrument>				
→48	SecurityID	Y*	See table 21 in document "Codification Tables" for a list of possible values	String	Underlying asset
762	SecuritySubType	Y*	See table 30 in document "Codification Tables" for a list of possible values	String	Strategy type
	End <Instrument>				
555	NoLegs	N		NumInGroup	
→	Start <InstrumentLeg>				
→600	LegSymbol	N		String(22)	Leg contract code
→623	LegRatioQty	N		Float	The ratio of quantity for this individual leg relative to the entire multileg security
→624	LegSide	N	1 = Buy 2 = Sell	Char	Indicates if the contract LegSymbol [600] is to buy or sell
→566	LegPrice	N		Price	Price for this leg
	End <InstrumentLeg>				
	Standard Trailer	Y			

8.5.2 Security Definition (Msg Type = d)

Message sent by HF MEFFGate to to accept or reject a Security Definition Request message

Tag	Name	Req	Valid values	Format	Description
	Standard Header	Y	MsgType = d		
1180	ApplID	N		String	Used in conjunction with ApplSeqNum [1181] to indicate, in subsequent connections, the point from which to receive information
1181	ApplSeqNum	N		SeqNum	Used in conjunction with ApplID [1180] to indicate, in subsequent connections, the point from which to receive information
320	SecurityReqID	N		String	Identifier assigned by the client in the Security Definition Request message
323	SecurityResponseType	N	1 = Accept 5 = Reject	Int	Status of the Security Definition Request message. If it contains the value "5" (Reject), there is an explanation for the rejection in the RejectText [1328] field.
	Start <Instrument>				
→55	Symbol	N		String	Security code for this strategy
→48	SecurityID	N	See table 21 in document "Codification Tables" for a list of possible values	String	Underlying asset
762	SecuritySubType	N	See table 30 in document "Codification Tables" for a list of possible values	String	Strategy type
	End <Instrument>				
58	Text	N		String	Long name for this strategy
555	NoLegs	N		NumInGroup	
→	Start <InstrumentLeg>				
→600	LegSymbol	N		String	Leg contract code
→623	LegRatioQty	N		Float	The ratio of quantity for this individual leg relative to the entire multileg security
→624	LegSide	N	1 = Buy 2 = Sell	Char	Indicates if the contract LegSymbol [600] is to buy or sell
→566	LegPrice	N		Price	Price for this leg
	End <InstrumentLeg>				
1328	RejectText	N		String	If SecurityResponseType [323] =

Tag	Name	Req	Valid values	Format	Description
	Standard Trailer	Y			"5" (Reject), there is an explanation of the rejection

9 Delta Protection, Kill Button, Management of Filters and Permissions

9.1 Introduction

This chapter covers these functions:

- Delta Protection + account configuration and MiFiD II tags for quotes
- Kill Button
- Management of Price Filters
- Management of Volume Filters
- Management of Volume Filters for HFT - IFTL (Maximum variation of the position)
- Management of Permissions

All these features are implemented through the use of Registration Instructions and Registration Instructions Response messages. In these messages the field RegistID is relevant, which is dedicated the next section.

There is a separate section on each of these functions in this chapter. There is a description of the method of use, the list of related messages, the message flow and the additions or annotations incorporated in this implementation for each function. At the end of the chapter there is a detailed description of all the messages included in the chapter.

The field RegistID, present in a request initiated by a Registration Instructions message, is the identifier that relates to the request with Registration Instructions Response messages.

The field RegistID assigned by the client should be ten characters length. If length is inferior, HF MEFFGate complete with spaces to achieve that length. HF MEFFGate also expects that messages sent by the client system use an RegistID of 30 length, in this case only the last ten positions are free, since the 20 first should coincide with the format explained below.

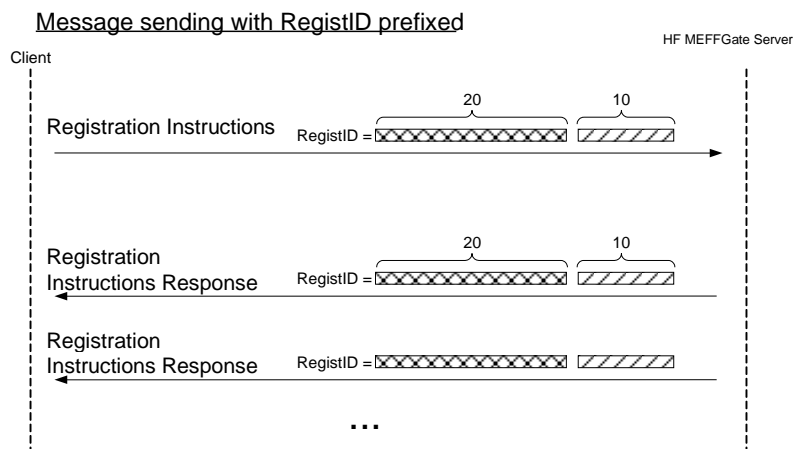
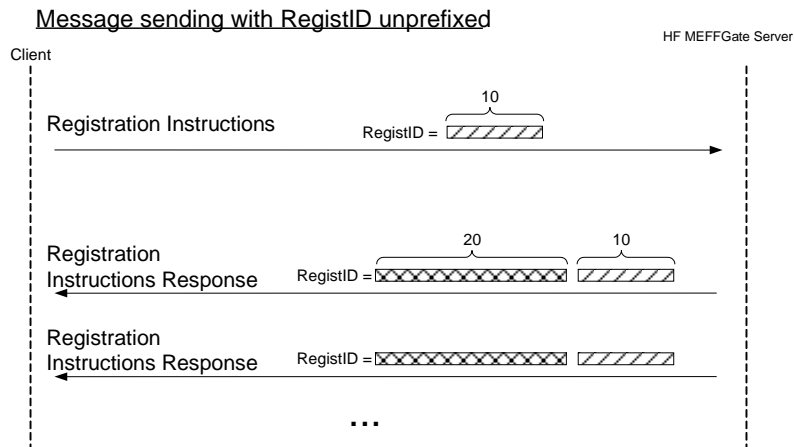

- Assigning of the prefix to the RegistID identifier -

A process in the HF MEFFGate of assigning a prefix to the RegistID field is performed to avoid duplicates in this identifier.

The RegistID assigned by MEFFGate in the reply message has the format AAMMDDMmmmTttMmmmTttNnnnnnnnnn, made by the following codes:

AAMMDD. It is the date of the business session

MmmmTtt. Contains the member and user code of connection from which the request was made

Nnnnnnnnnn. It is the value assigned by the client application to RegistID in the original message

A user who wants to send a modification or cancellation, must use this identifier in the field RegistRefID of the Registration Instructions request message.

9.3 Delta protection + Account configuration and MiFiD II tags for quotes

Each FIX client can activate this protection for its quotes and orders, for a contract group, as follows:

- Time period considered for delta protection (between 1 and 60 seconds)
- Reasons for cancellation due to delta protection. Three limits, which act independently, can be configured during an established time period:
 - Total volume of traded contracts
 - Delta:
 - Options: $\text{abs}[\text{Volume of (Calls buy + Puts sell)} - (\text{Calls sell} + \text{Puts buy})]$
 - Futures: $\text{abs}[\text{Volume of (Futures buy)} - \text{Futures sell}]$
 - $\text{abs}[\text{Total buy volume} - \text{Total sell volume}]$

Contract groups can be defined as:

- In Equity Derivatives with a single stock or index as an underlying: there is a contract group for each underlying and contract type (futures, options or strategies)
- In xRolling FX derivatives: all of the currency pairs together constitute one single contract group

When a value zero is configured, MEFF central system will not control this specific concept.

If the trader does not wish to activate delta protection, the "period of time for delta protection" parameter has to be configured with the value zero.

After each trade, a check is performed to ascertain if the aggregated volume on 'M' type trades during the last n seconds (as defined in the corresponding parameter) for the trader, underlying asset, contract type and account equals or exceeds any of the three controls defined in the delta protection.

Once the delta protection filter has been triggered the delta protection parameters are deactivated and all trader's pending orders and quotes on this underlying asset, contract type and account are cancelled.

In order to protect from executions on the fly, no new orders or no new quotes on this underlying asset and contract type will be admitted, until the HF MEFFGate client sends a new Registration Instructions message, message type "o", reactivating the limits with `RegistTransType [514] = 1 (Replace)`. Sending this message implies setting to zero the trade volume counters in the corresponding underlying asset and contract type. Note that it is also possible to cancel the existing, deactivated parameters, with `RegistTransType [514] = 2 (Cancel)` and then register new parameters in the usual way.

It must be taken into account that during auction resolution the delta protection feature doesn't apply.

These are the MiFiD II tags which can be configured:

- Client identification (PartyRole [452] with value 3)
- Party responsible for the investment decision within Firm (PartyRole [452] with value 122)
- Party responsible for the Execution within Firm (PartyRole [452] with value 12)
- DEA order flag (OrderOrigination [1724])
- Liquidity provision flag (OrderAttributeType [2594] = 2 + OrderAttributeValue [2595] = "Y")
- Trading capacity (LastCapacity [29])
- Self-execution prevention (SelfMatchPreventionID [2362])

9.3.1 List of messages

Message	Description
Registration Instructions (Msg Type = o)	Used by the client to manage the configuration of the quote account parameters and MiFiD II tags and delta protection
Registration Instructions Response (Msg Type = p)	Sent by HF MEFFGate to notify or reject the configuration of the quote account parameters MiFiD II tags and delta protection

9.3.2 Message flow

Correct request

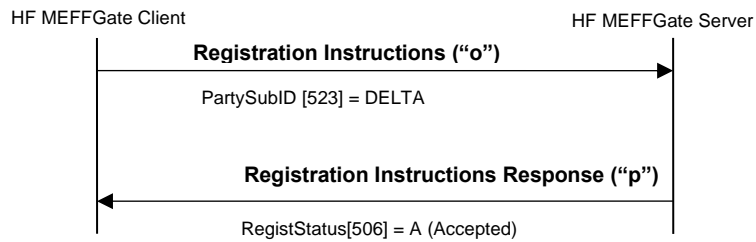

Incorrect request

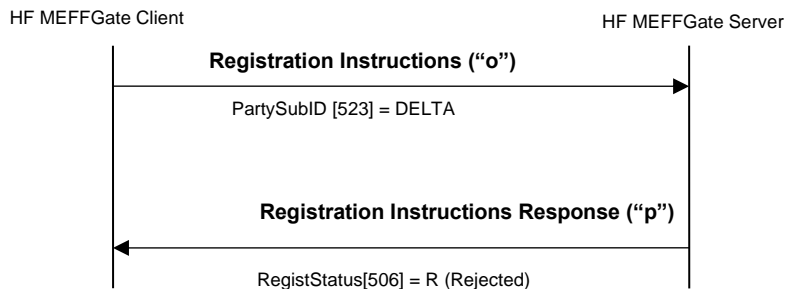

9.3.3 Annotations and adaptations of FIX 5.0

- In the Registration Instructions message, the fields Account [1], SecurityType [167], NoPartyIDs [453] and NoPartySubIDs [802] are now required
- The field RejectText [1328] has been added to the Registration Instructions Response message
- The fields OrderOrigination [1724], OrderAttributeType [2594], OrderAttributeValue [2595] and LastCapacity [29] have been added to the Registration Instructions and Registration Instructions Response messages
- The blocks Instrument and Stipulations have been added as required to the Registration Instructions message
- The blocks Instrument and Stipulations have been added to the Registration Instructions Response message

- The field AlgorithmicTradeIndicator [2667] has been added to the Registration Instructions and Registration Instructions Response messages
- The field SelfMatchPreventionID [2362] has been added to the Registration Instructions and Registration Instructions Response messages

9.3.4 Definition of messages

9.3.4.1 Registration Instructions (Msg Type = o)

Message sent by the client to manage the configuration of the quote account parameters and MiFiD II tags and delta protection

Tag	Name	Req	Valid values	Format	Description
	Standard Header	Y	MsgType = o		
513	RegistID	Y	0 = New	String	Unique identifier for each Registration Instructions message
514	RegistTransType	Y	1 = Replace 2 = Cancel	Char	
508	RegistRefID	N		String	Reference identifier for the RegistID (513) with Cancel and Replace RegistTransType (514) transaction types. Required if RegistTransType = 1 or 2
Start <Parties>					
453	NoPartyIDs	Y*		NumInGroup	
→ 448	PartyID	Y*	For PartyRole [452] = 3, 12 or 122, this is an unsigned integer field, greater or equal than 0 and less than 2 ³²	String	See section 4.3 - Parties block
→ 447	PartyIDSource	Y*	D = Proprietary/ Custom code P = Short code identifier 3 = Client ID 11 = Order Origination Trader 12 = Execution within Firm ID	Char	<ul style="list-style-type: none"> Value "P" for PartyRole [452] = 3, 12 or 122 Else value "D"
→ 452	PartyRole	Y*	13 = Order Origination Firm 122 = Investment Decision within Firm ID See "4.3 -	Int	

Tag	Name	Req	Valid values	Format	Description
			Parties block" for more details		
→ 802	NoPartySubIDs	Y*	1	NumInGroup	
→→ 523	PartySubID	Y*	DELTA = Delta protection and configuration of the quote account parameters	String	
	End <Parties>				
1	Account	Y*		String (5)	Account to be applied for the next quotes of futures or options of this underlying asset for this Member- Trader (Order Origination Firm- Order Origination Trader)
	Start <Instrument>				
55*	Symbol	Y	[N/A]	String	
48*	SecurityID	N	See table 21 in document "Codification Tables" for a list of possible values	String	Underlying asset Mandatory for Equity Derivatives
22*	SecurityIDSource	N	8 = Exchange Symbol	String	Mandatory for Equity Derivatives
167*	SecurityType	N	See table 31 of document "Codification Tables" for details of the Trade Type codes		Product type Mandatory for Equity Derivatives
	End <Instrument>				
	Start <Stipulations>				
232*	NoStipulations	Y*		NumInGroup	
			TIMEDP = Period of time for delta protection		
→ 233*	StipulationType	Y*	VOLUMETOT = Total volume of traded contracts	String	
			DELTA = Resultant delta		
			BAL = Resultant net balance (buy-sell)		
→ 234*	StipulationValue	Y*	A numeric value, >= 0, no	String	StipulationType = "TIMEDP". This refers to the period of time to be

Tag	Name	Req	Valid values	Format	Description
			decimals		<p>applied for delta protection controls taking into account the futures and options of this underlying asset for this Member-Trader code (Order Origination Firm-Order Origination Trader). This is a value expressed in seconds (>1, <=60). If no control has to be applied, this field has to be filled with a 0 (zero).</p> <p>StipulationType = "VOLUMETOT". This refers to the total volume of traded contracts accumulated in the period of time established. These contracts correspond to the futures and options of this underlying asset and traded by this Member-Trader code (Order Origination Firm-Order Origination Trader). If no control has to be applied, this field has to be filled with a 0 (zero).</p> <p>StipulationType = "DELTA". This refers to the resultant delta accumulated in the period of time established, for futures and options of this underlying asset and traded by this Member-Trader code (Order Origination Firm-Order Origination Trader). If no control has to be applied, this field has to be filled with a 0 (zero).</p> <p>StipulationType = "BAL". This refers to the resultant net balance (buy-sell) accumulated in the period of time established, for futures and options of this underlying asset and traded by this Member-Trader code (Order Origination Firm-Order Origination Trader). If no control has to be applied, this field has to be filled with a 0 (zero).</p>
End <Stipulations>					
1724*	OrderOrigination	N	5 = Order received from a direct access or sponsored access customer	Int	DEA order flag
Start <OrdAttrib>					
2593*	NoOrderAttributes	N		NumInGroup	
→2594*	OrderAttributeType	N	2	String	Liquidity provision flag
→2595*	OrderAttributeValue	N	Y	String	Liquidity provision flag

Tag	Name	Req	Valid values	Format	Description
	e End <OrdAttrib>				
			1 = "AOTC"		
29*	LastCapacity	N	3 = "MTCH"	Char	Trading capacity
			4 = "DEAL"		
2667*	AlgorithmicTradeIndicator	N	1 = Algorithmic (submitted by a trading algorithm)	Int	Algorithmic order flag
2362*	SelfMatchPreventionID	N	Numeric, > 0, <= 999	String	Self-execution prevention
	Standard Trailer	Y			

9.3.4.2 Registration Instructions Response (Msg Type = p)

Message used by HF MEFFGate to indicate the status of the request initiated with the Registration Instructions message of the configuration of the quote account parameters and MiFiD II tags and delta protection

This message is only sent to the user who made the request.

Tag	Name	Req	Valid values	Format	Description
	Standard Header	Y	MsgType = p		
1180	ApplID	N		String	Used in conjunction with ApplSeqNum [1181] to indicate, in subsequent connections, the point from which to receive information
1181	ApplSeqNum	N		SeqNum	Used in conjunction with ApplID [1180] to indicate, in subsequent connections, the point from which to receive information
513	RegistID	Y		String	Identifier assigned by the client in the Registration Instructions message
			0 = New		
514	RegistTransType	Y	1 = Replace 2 = Cancel	Char	
508	RegistRefID	N		String	Identifier of Registration Instructions message which is replaced or cancelled by this message. Included when RegistTransType = 1 or 2
	Start <Parties>				
453	NoPartyIDs	N		NumInGroup	
→ 448	PartyID	N		String	See section 4.3 - Parties block
→ 447	PartyIDSource	N	D = Proprietary/ Custom code P = Short code identifier 3 = Client ID	Char	<ul style="list-style-type: none"> Value "P" for PartyRole [452] = 3, 12 or 122 Else value "D"
→ 452	PartyRole	N	11 = Order Origination Trader 12 = Execution within Firm ID 13 = Order Origination Firm 122 = Investment Decision within	Int	

Tag	Name	Req	Valid values	Format	Description
			Firm ID		
			...		
			See "4.3 - Parties block" for more details		
→ 802	NoPartySubIDs	N	1	NumInGroup	
→→ 523	PartySubID	N	DELTA = Delta protection and configuration of the quote account parameters	String	
→→ 803	PartySubIDType	N		Int	The content of this field should not be considered
	End <Parties>				
1	Account	N		String	Account to be applied for the next quotes of futures or options of this underlying asset for this Member-Trader (Order Origination Firm-Order Origination Trader)
	Start <Instrument>				
55*	Symbol	Y	[N/A]	String	
48*	SecurityID	N	See table 21 in document "Codification Tables" for a list of possible values	String	Underlying asset
22*	SecurityIDSource	N	8 = Exchange Symbol	String	
167*	SecurityType	N	See table 31 of document "Codification Tables" for details of the Trade Type codes	String	Product type
	End <Instrument>				
	Start <Stipulations>				
232*	NoStipulations	N		NumInGroup	
→ 233*	StipulationType	N	TIMEDP = Period of time for delta protection VOLUMETOT = Total volume of traded contracts	String	

Tag	Name	Req	Valid values	Format	Description
			DELTA = Resultant delta		
			BAL = Resultant net balance (buy-sell)		
					StipulationType = "TIMEDP". This refers to the period of time to be applied for delta protection controls taking into account the futures and options of this underlying asset for this Member-Trader code (Order Origination Firm-Order Origination Trader). This is a value expressed in seconds (>1, <=60). If no control has to be applied, this field has to be filled with a 0 (zero).
					StipulationType = "VOLUMETOT". This refers to the total volume of traded contracts accumulated in the period of time established. These contracts correspond to the futures and options of this underlying asset and traded by this Member-Trader code (Order Origination Firm-Order Origination Trader). If no control has to be applied, this field has to be filled with a 0 (zero).
→ 234*	StipulationValue	N		String	
					StipulationType = "DELTA". This refers to the resultant delta accumulated in the period of time established, for futures and options of this underlying asset and traded by this Member-Trader code (Order Origination Firm-Order Origination Trader). If no control has to be applied, this field has to be filled with a 0 (zero)
					StipulationType = "BAL". This refers to the resultant net balance (buy-sell) accumulated in the period of time established, for futures and options of this underlying asset and traded by this Member-Trader code (Order Origination Firm-Order Origination Trader). If no control has to be applied, this field has to be filled with a 0 (zero)
	End <Stipulations>				
506	RegistStatus	Y	A = Accepted	Char	Status of the Registration

Tag	Name	Req	Valid values	Format	Description
			R = Rejected		Instructions request message. If it contains the value "R", there is an explanation for the rejection in the RejectText [1328] field
1328*	RejectText	N		String	If RegistStatus = "R" there is an explanation of the rejection
1724*	OrderOrigination	N	5 = Order received from a direct access or sponsored access customer	Int	DEA order flag
2593*	Start <OrdAttrib> NoOrderAttributes	N		NumInGroup	
→2594*	OrderAttributeType	N	2	String	Liquidity provision flag
→2595*	OrderAttributeValue	N	Y	String	Liquidity provision flag
	End <OrdAttrib>				
29*	LastCapacity	N	1 = "AOTC" 3 = "MTCH" 4 = "DEAL"	Char	Trading capacity
2667*	AlgorithmicTradeIndicator	N	1 = Algorithmic (submitted by a trading algorithm)	Int	Algorithmic order flag
2362*	SelfMatchPreventionID	N	Numeric, > 0, <= 999	String	Self-execution prevention
	Standard Trailer	Y			

Allows:

- a) Clearing Members (authorised users): Suspend a non-clearing member cleared by the clearing member. The use of this functionality implies the suspension of all the member's traders, the cancellation of pending orders, quotes and block trades pending acceptance.
- b) Non-clearing members (authorised users): Suspend a trader within this non-clearing member. The use of this functionality implies the cancellation of pending orders, quotes and block trades pending acceptance.

The reactivation of member or trader has to be requested from Market Supervision.

9.4.1 List of messages

Message	Description
Registration Instructions (Msg Type = o)	Used by the client to send a Kill Button
Registration Instructions Response (Msg Type = p)	Sent by HF MEFFGate to notify or reject the Kill Button request

9.4.2 Message flow

Correct request

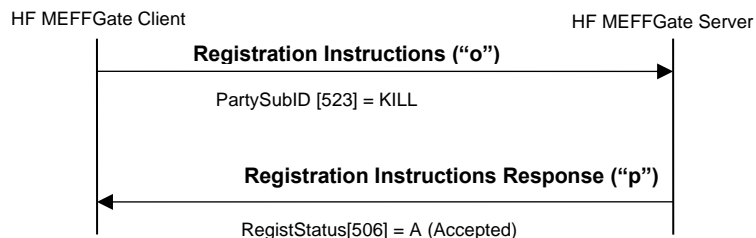

Incorrect request

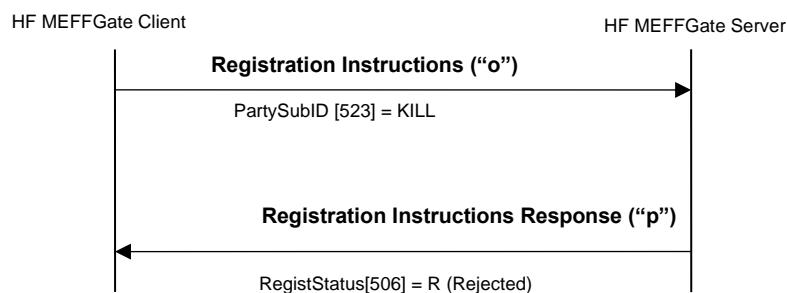

9.4.3 Annotations and adaptations of FIX 5.0

- In the Registration Instructions message, the fields NoPartyIDs [453] and NoPartySubIDs [802] are now required
- The field RejectText [1328] has been added to the Registration Instructions Response message

9.4.4 Definition of messages

9.4.4.1 Registration Instructions (Msg Type = o)

Message sent by the client to send a Kill Button

Tag	Name	Req	Valid values	Format	Description
	Standard Header	Y	MsgType = o		
513	RegistID	Y		String	Unique identifier for each Registration Instructions message
514	RegistTransType	Y	0 = New	Char	
508	RegistRefID	N		String	Reference identifier for the RegistID (513) with Cancel and Replace RegistTransType (514) transaction types. Required if RegistTransType = 1 or 2
	Start <Parties>				
453	NoPartyIDs	Y*		NumInGroup	
→ 448	PartyID	Y*		String	Member / Trader codes which acts this configuration
→ 447	PartyIDSource	Y*	D = Proprietary / Custom code	String	
			13 = Order Origination Firm		
→ 452	PartyRole	Y*	11 = Order Origination Trader	Int	
			See "4.3 - Parties block" for more details		
→ 802	NoPartySubIDs	Y*	1	NumInGroup	
→→ 523	PartySubID	Y*	KILL = Kill Button	String	
	End <Parties>				
	Standard Trailer	Y			

9.4.4.2 Registration Instructions Response (Msg Type = p)

Message used by HF MEFFGate to indicate the status of the request initiated with the Registration Instructions message (Kill Button).

This message is only sent to the user who made the request.

Tag	Name	Req	Valid values	Format	Description
	Standard Header	Y	MsgType = p		
1180	ApplID	N		String	Used in conjunction with ApplSeqNum [1181] to indicate, in subsequent connections, the point from which to receive information
1181	ApplSeqNum	N		SeqNum	Used in conjunction with ApplID [1180] to indicate, in subsequent connections, the point from which to receive information
513	RegistID	Y		String	Identifier assigned by the client in the Registration Instructions message
514	RegistTransType	Y	0 = New	Char	
508	RegistRefID	N		String	Identifier of Registration Instructions message which is replaced or cancelled by this message. Included when RegistTransType = 1 or 2
	Start <Parties>				
453	NoPartyIDs	N		NumInGroup	
→ 448	PartyID	N		String	Member / Trader codes which acts this configuration
→ 447	PartyIDSource	N	D = Proprietary / Custom code	String	
			13 = Order Origination Firm		
→ 452	PartyRole	N	11 = Order Origination Trader	Int	
			See "4.3 - Parties block" for more details		
→ 802	NoPartySubIDs	N	1	NumInGroup	
→→ 523	PartySubID	N	KILL = Kill Button	String	
→→ 803	PartySubIDType	N		Int	The content of this field should not be considered
	End <Parties>				
506	RegistStatus	Y	A = Accepted R = Rejected	Char	Status of the Registration Instructions request message. If it contains the value "R", there is an explanation for the rejection in the RejectText [1328] field

Tag	Name	Req	Valid values	Format	Description
1328*	RejectText	N		String	If RegistStatus = "R" there is an explanation of the rejection
	Standard Trailer	Y			

9.5 Management of Price Filters

Allows Non-clearing Members Members (authorised users), to define a maximum price filter, in an specific underlying and family of products, for each of its traders. This value must always be more restrictive than the default value set by MEFF for the market.

The configuration of this filter, within each underlying and family of products, will be in ticks or as a percentage with a minimum of ticks and will correspond to the maximum price variation of the order with respect to the base price filter in normal and in “fast market” states.

As it is explained in section “3.7 - Synchronisation at application level”, when a client initiates a FIX session (Logon message accepted), it receives the Registration Instructions and Registration Instructions Response messages (which indicates the user’s established price filters and when the user has the relevant permissions, those of the other traders of the entity).

9.5.1 List of messages

Message	Description
Registration Instructions (Msg Type = o)	Used by the client to manage the configuration of the Price filters
Registration Instructions Response (Msg Type = p)	Sent by HF MEFFGate to notify or reject the configuration of the Price filters

9.5.2 Message flow

Correct request of non-clearing member by its own traders (including itself)

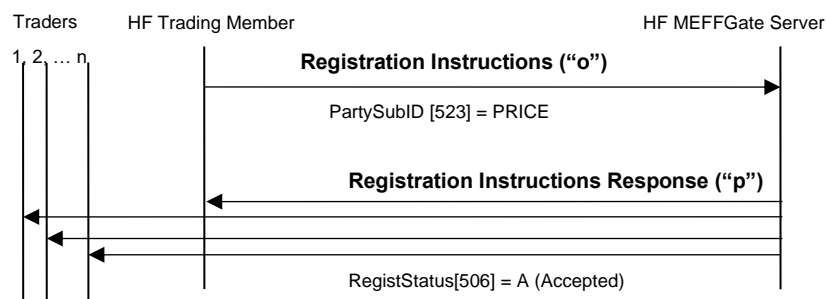

Incorrect request

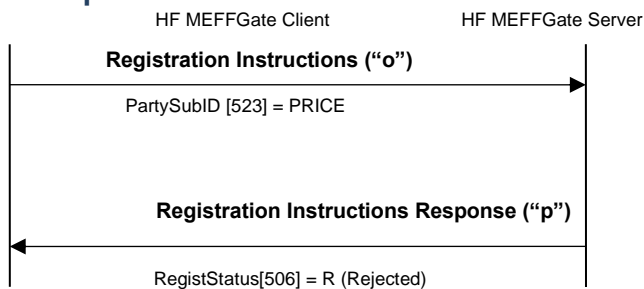

9.5.3 Annotations and adaptations of FIX 5.0

- In the Registration Instructions message, the fields NoPartyIDs [453] and NoPartySubIDs [802] are now required
- The field RejectText [1328] has been added to the Registration Instructions Response message
- The blocks Instrument and Stipulations have been added as required to the Registration Instructions message
- The blocks Instrument and Stipulations have been added to the Registration Instructions Response message

9.5.4 Definition of messages

9.5.4.1 Registration Instructions (Msg Type = o)

Message sent by the client to manage the configuration of the Price filters

Tag	Name	Req	Valid values	Format	Description
	Standard Header	Y	MsgType = o		
513	RegistID	Y	0 = New	String	Unique identifier for each Registration Instructions message
514	RegistTransType	Y	1 = Replace 2 = Cancel	Char	
508	RegistRefID	N		String	Reference identifier for the RegistID (513) with Cancel and Replace RegistTransType (514) transaction types. Required if RegistTransType = 1 or 2
	Start <Parties>				
453	NoPartyIDs	Y*		NumInGroup	
→ 448	PartyID	Y*		String	Member and Trader codes which acts this configuration
→ 447	PartyIDSource	Y*	D = Proprietary / Custom code 13 = Order Origination Firm	String	
→ 452	PartyRole	Y*	11 = Order Origination Trader See "4.3 - Parties block" for more details	Int	
→ 802	NoPartySubIDs	Y*	1	NumInGroup	
→→ 523	PartySubID	Y*	PRICE = Price Filters configuration	String	
	End <Parties>				
	Start <Instrument>				
55*	Symbol	Y	[N/A]	String	
48*	SecurityID	Y*	See table 21 in document "Codification Tables" for a list of possible values	String	Underlying asset
22*	SecurityIDSource	Y*	8 = Exchange Symbol	String	
1151 *	SecurityGroup	Y*	See table 28 in document "Codification Tables" for a list	String	Product family

Tag	Name	Req	Valid values of values	Format	Description
	End <Instrument> Start <Stipulations>				
232*	NoStipulations	Y*		NumInGroup	
			TP = Ticks/Percentage		
			TICKS_N = Maximum price difference to apply in a normal state		
			PERCENT_N = Percentage to apply in a normal state		
→ 233*	StipulationType	Y*	TICKS_F = Maximum price difference to apply for a "fast market" state	String	
			PERCENT_F = Percentage to apply for a "fast market" state		
			TICKMIN = Minimum number of ticks to apply (Configuration by percentage)		
					If StipulationType [233] = "TP", indicates the type of configuration: "T": Configuration by ticks "P": Configuration by percentage
→ 234*	StipulationValue	Y*		String	If StipulationValue [234] = T (configuration by ticks), it is necessary to implement the number of ticks to apply in a normal state, between the price of the order and the base price filter, in the tag StipulationValue [234] for StipulationType [233] = "TICKS_N". It is necessary to implement as well, for a "fast market" state, the same information in the tag StipulationValue [234] for

Tag	Name	Req	Valid values	Format	Description
					<p>StipulationType [233] = "TICKS_F".</p> <p>If StipulationValue [234] = P (configuration by percentage), it is necessary to implement the percentage to apply in a normal state, between the price of the order and the base price filter, in the tag StipulationValue [234] for StipulationType [233] = "PERCENT_N" and also the minimum number of ticks to apply in the tag StipulationValue [234] for StipulationType [233] = "TICKMIN". It is necessary to implement as well, for a "fast market" state, the same information in the tag StipulationValue [234] for StipulationType [233] = "PERCENT_F" and for StipulationType [233] = "TICKMIN".</p>
	End <Stipulations>				
	Standard Trailer	Y			

9.5.4.2 Registration Instructions Response (Msg Type = p)

Message used by HF MEFFGate to indicate the status of the request initiated with the Registration Instructions message of the Price filters.

This message is sent to the user who made the request and related users affected by the new filter

Tag	Name	Req	Valid values	Format	Description
	Standard Header	Y	MsgType = p		
1180	ApplID	N		String	Used in conjunction with ApplSeqNum [1181] to indicate, in subsequent connections, the point from which to receive information
1181	ApplSeqNum	N		SeqNum	Used in conjunction with ApplID [1180] to indicate, in subsequent connections, the point from which to receive information
513	RegistID	Y		String	Identifier assigned by the client in the Registration Instructions message
			0 = New		
514	RegistTransType	Y	1 = Replace 2 = Cancel	Char	
508	RegistRefID	N		String	Identifier of Registration Instructions message which is replaced or cancelled by this message. Included when RegistTransType = 1 or 2
	Start <Parties>				
453	NoPartyIDs	N		NumInGroup	
→ 448	PartyID	N		String	Member and Trader codes which acts this configuration
→ 447	PartyIDSource	N	D = Proprietary / Custom code	String	
			13 = Order Origination Firm		
→ 452	PartyRole	N	11 = Order Origination Trader ... See "4.3 - Parties block" for more details	Int	
→ 802	NoPartySubIDs	N	1	NumInGroup	
→→ 523	PartySubID	N	PRICE = Price Filters configuration	String	
→→ 803	PartySubIDType	N		Int	The content of this field should not be considered
	End <Parties>				

Tag	Name	Req	Valid values	Format	Description
	Start <Instrument>				
55*	Symbol	Y	[N/A]	String	
48*	SecurityID	N	See table 21 in document "Codification Tables" for a list of possible values	String	Underlying asset
22*	SecurityIDSource	N	8 = Exchange Symbol	String	
1151*	SecurityGroup	N	See table 28 in document "Codification Tables" for a list of values	String	Product family
	End <Instrument>				
	Start <Stipulations>				
232*	NoStipulations	N		NumInGroup	
			TP = Ticks/Percentage		
			TICKS_N = Number of ticks to apply in a normal state		
			PERCENT_N = Percentage to apply in a normal state		
→ 233*	StipulationType	N	TICKS_F = Number of ticks to apply for a "fast market" state PERCENT_F = Percentage to apply for a "fast market" state TICKMIN = Minimum number of ticks to apply (Configuration by percentage)	String	
→ 234*	StipulationValue	N		String	
	End <Stipulations>				

Tag	Name	Req	Valid values	Format	Description
506	RegistStatus	Y	A = Accepted R = Rejected	Char	Status of the Registration Instructions request message. If it contains the value "R", there is an explanation for the rejection in the RejectText [1328] field
1328*	RejectText	N		String	If RegistStatus = "R" there is an explanation of the rejection
	Standard Trailer	Y			

9.6 Management of Volume Filters

Allows:

- a) Clearing Members (authorised users): Define a maximum order size, in a family of products, for those non-clearing members which it clears. This value must always be more restrictive than the default value set by MEFF for the market. For this feature, value VOL_C must be used in PartySubID [523] of the Registration Instructions message (see 9.6.4.1).
- b) Non-clearing Members (authorised users): Define a maximum order size, in a family of products, for each of its traders. This value must always be more restrictive than the default value set by its Clearing Member or by MEFF for the market. For this feature, value VOL_T must be used in PartySubID [523] of the Registration Instructions message (see 9.6.4.1).

As it is explained in section “3.7 - Synchronisation at application level”, when a client initiates a FIX session (Logon message accepted), it receives the Registration Instructions and Registration Instructions Response messages (which indicates the user’s established volume filters and when the user has the relevant permissions, those of the other traders of the entity and of the members cleared by the entity).

9.6.1 List of messages

Message	Description
Registration Instructions (Msg Type = o)	Used by the client to manage the configuration of the Volume filters
Registration Instructions Response (Msg Type = p)	Sent by HF MEFFGate to notify or reject the configuration of the Volume filters

9.6.2 Message flow

Correct request of clearing member by its own non-clearing members

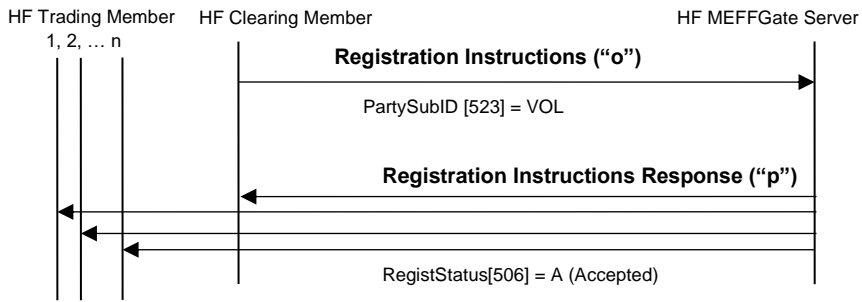

Correct request of non-clearing member by its own traders (including itself)

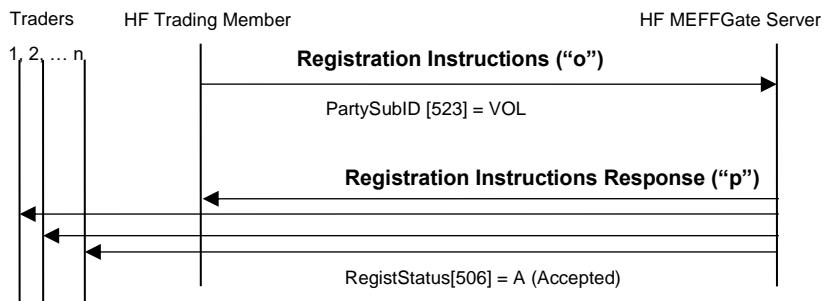

Incorrect request

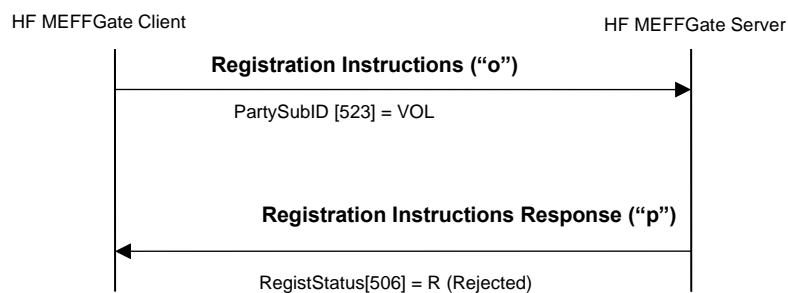

9.6.3 Annotations and adaptations of FIX 5.0

- In the Registration Instructions message, the fields NoPartyIDs [453] and NoPartySubIDs [802] are now required
- The field RejectText [1328] has been added to the Registration Instructions Response message

- The blocks Instrument and Stipulations have been added as required to the Registration Instructions message
- The blocks Instrument and Stipulations have been added to the Registration Instructions Response message

9.6.4 Definition of messages

9.6.4.1 Registration Instructions (Msg Type = o)

Message sent by the client to manage the configuration of the Volume filters

Tag	Name	Req	Valid values	Format	Description
	Standard Header	Y	MsgType = o		
513	RegistID	Y	0 = New	String	Unique identifier for each Registration Instructions message
514	RegistTransType	Y	1 = Replace 2 = Cancel	Char	
508	RegistRefID	N		String	Reference identifier for the RegistID (513) with Cancel and Replace RegistTransType (514) transaction types. Required if RegistTransType = 1 or 2
	Start <Parties>				
453	NoPartyIDs	Y*		NumInGroup	
→ 448	PartyID	Y*		String	Member and Trader codes which acts this configuration
→ 447	PartyIDSource	Y*	D = Proprietary / Custom code 13 = Order Origination Firm	String	
→ 452	PartyRole	Y*	11 = Order Origination Trader See "4.3 - Parties block" for more details	Int	
→ 802	NoPartySubIDs	Y*	1	NumInGroup	
→→ 523	PartySubID	Y*	VOL_C = Price Filters configuration acting as a Clearing Member VOL_T = Price Filters configuration acting as a Non-Clearing Member	String	
	End <Parties>				
	Start <Instrument>				
55*	Symbol	Y	[N/A]	String	
1151	SecurityGroup	Y*	See table 28 in	String	Product family

Tag	Name	Req	Valid values	Format	Description
*			document "Codification Tables" for a list of values		
	End <Instrument>				
	Start <Stipulations>				
232*	NoStipulations	Y*		NumInGroup	
→ 233*	StipulationType	Y*	MAXORD = Maximum otrder size	String	
→ 234*	StipulationValue	Y*		String	When StipulationType [233] = "MAXORD", indicates the maximum order size (it should be a numeric value, >= 0, <=9999, no decimals)
	End <Stipulations>				
	Standard Trailer	Y			

9.6.4.2 Registration Instructions Response (Msg Type = p)

Message used by HF MEFFGate to indicate the status of the request initiated with the Registration Instructions message of the Volume filters.

This message is sent to the user who made the request and related users affected by the new filter

Tag	Name	Req	Valid values	Format	Description
	Standard Header	Y	MsgType = p		
1180	ApplID	N		String	Used in conjunction with ApplSeqNum [1181] to indicate, in subsequent connections, the point from which to receive information
1181	ApplSeqNum	N		SeqNum	Used in conjunction with ApplID [1180] to indicate, in subsequent connections, the point from which to receive information
513	RegistID	Y		String	Identifier assigned by the client in the Registration Instructions message
			0 = New		
514	RegistTransType	Y	1 = Replace 2 = Cancel	Char	
508	RegistRefID	N		String	Identifier of Registration Instructions message which is replaced or cancelled by this message. Included when RegistTransType = 1 or 2
	Start <Parties>				
453	NoPartyIDs	N		NumInGroup	
→ 448	PartyID	N		String	Member and Trader codes which acts this configuration
→ 447	PartyIDSource	N	D = Proprietary / Custom code 13 = Order Origination Firm	String	
→ 452	PartyRole	N	11 = Order Origination Trader See "4.3 - Parties block" for more details	Int	
→ 802	NoPartySubIDs	N	1	NumInGroup	
→→ 523	PartySubID	N	VOL_C = Price Filters configuration acting as a Clearing Member	String	

Tag	Name	Req	Valid values	Format	Description
			VOL_T = Price Filters configuration acting as a Non-Clearing Member		
→→ 803	PartySubIDType	N		Int	The content of this field should not be considered
	End <Parties>				
55*	Symbol	Y	[N/A]	String	
1151*	SecurityGroup	N	See table 28 in document "Codification Tables" for a list of values	String	Product family
	End <Instrument>				
	Start <Stipulations>				
232*	NoStipulations	N		NumInGroup	
→ 233*	StipulationType	N	MAXORD = Maximum order size	String	
→ 234*	StipulationValue	N		String	
	End <Stipulations>				
506	RegistStatus	Y	A = Accepted R = Rejected	Char	Status of the Registration Instructions request message. If it contains the value "R", there is an explanation for the rejection in the RejectText [1328] field
1328*	RejectText	N		String	If RegistStatus = "R" there is an explanation of the rejection
	Standard Trailer	Y			

9.7 Management for HFT - IFTL (Maximum variation of the position)

For HF MEFFGate users with this filter activated, the corresponding maximum variation of the position filter configuration will be defined by its Clearing Member.

When a new filter (or a modification of a previous one) is entered, an initial position can be established. By default, the initial position is zero.

As it is explained in section “3.7 - Synchronisation at application level”, when a client initiates a FIX session (Logon message accepted), it receives the Registration Instructions and Registration Instructions Response messages (which indicates the user’s established “Configuration for HFT - IFTL / Maximum variation of the position” and when the user has the relevant permissions, those of the other traders of the entity).

9.7.1 List of messages

Message	Description
Registration Instructions (Msg Type = o)	Used by the client to manage the configuration for HFT - IFTL (Maximum variation of the position)
Registration Instructions Response (Msg Type = p)	Sent by HF MEFFGate to notify or reject the configuration for HFT - IFTL (Maximum variation of the position)

9.7.2 Message flow

Correct request

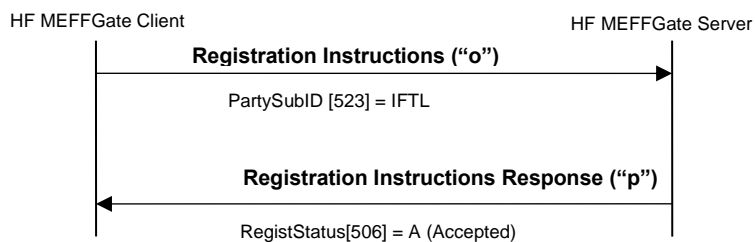

Incorrect request

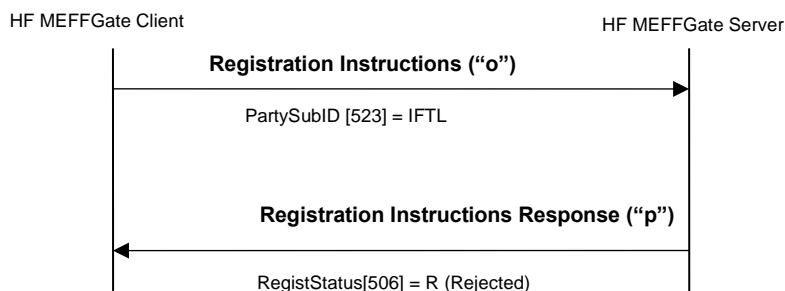

9.7.3 Annotations and adaptations of FIX 5.0

- In the Registration Instructions message, the fields NoPartyIDs [453] and NoPartySubIDs [802] are now required
- The field RejectText [1328] has been added to the Registration Instructions Response message
- The blocks Instrument and Stipulations have been added as required to the Registration Instructions message
- The blocks Instrument and Stipulations have been added to the Registration Instructions Response message

9.7.4 Definition of messages

9.7.4.1 Registration Instructions (Msg Type = o)

Message sent by the client to manage the configuration for HFT – IFTL (Maximum variation of the position)

Tag	Name	Req	Valid values	Format	Description
	Standard Header	Y	MsgType = o		
513	RegistID	Y		String	Unique identifier for each Registration Instructions message
			0 = New		
514	RegistTransType	Y	1 = Replace 2 = Cancel	Char	
508	RegistRefID	N		String	Reference identifier for the RegistID (513) with Cancel and Replace RegistTransType (514) transaction types. Required if RegistTransType = 1 or 2
	Start <Parties>				
453	NoPartyIDs	Y*		NumInGroup	
→ 448	PartyID	Y*		String	Member and Trader codes which acts this configuration
→ 447	PartyIDSource	Y*	D = Proprietary / Custom code	String	
			13 = Order Origination Firm		
→ 452	PartyRole	Y*	11 = Order Origination Trader	Int	
			See "4.3 - Parties block" for more details		
→ 802	NoPartySubIDs	Y*	1	NumInGroup	
→→ 523	PartySubID	Y*	IFTL = Maximum variation of the position	String	
	End <Parties>				
1	Account	N		String	When not specified: filter applies to the member. If three characters specified: filter applies to the holder.
	Start <Instrument>				
55*	Symbol	Y	[N/A]	String	
			See table 21 in document		Underlying asset.
48*	SecurityID	Y*	"Codification Tables" for a list of possible values	String	For IBEX and MiniIBEX: SecurityID [48] = FIE (because IBEX and MiniIBEX are using the same counter)

Tag	Name	Req	Valid values	Format	Description
22*	SecurityIDSource	Y*	8 = Exchange Symbol	String	
	End <Instrument>				
	Start <Stipulations>				
232*	NoStipulations	Y*		NumInGroup	
→ 233*	StipulationType	Y*	MAXVARPOS = Maximum position INIPOS = Initial position	String	
→ 234*	StipulationValue	Y*	A numeric value, no decimals	String	When StipulationType [233] = MAXVARPOS, indicates the maximum variation of the position (in absolute value) When StipulationType [233] = INIPOS, indicates Initial position (with sign)
	End <Stipulations>				
	Standard Trailer	Y			

9.7.4.2 Registration Instructions Response (Msg Type = p)

Message used by HF MEFFGate to indicate the status of the request initiated with the Registration Instructions message for HFT - IFTL (Maximum variation of the position).

This message is sent to the user who made the request and related users affected by the new filter

Tag	Name	Req	Valid values	Format	Description
	Standard Header	Y	MsgType = p		
1180	ApplID	N		String	Used in conjunction with ApplSeqNum [1181] to indicate, in subsequent connections, the point from which to receive information
1181	ApplSeqNum	N		SeqNum	Used in conjunction with ApplID [1180] to indicate, in subsequent connections, the point from which to receive information
513	RegistID	Y		String	Identifier assigned by the client in the Registration Instructions message
			0 = New		
514	RegistTransType	Y	1 = Replace 2 = Cancel	Char	
508	RegistRefID	N		String	Identifier of Registration Instructions message which is replaced or cancelled by this message. Included when RegistTransType = 1 or 2
	Start <Parties>				
453	NoPartyIDs	N		NumInGroup	
→ 448	PartyID	N		String	Member and Trader codes which acts this configuration
→ 447	PartyIDSource	N	D = Proprietary / Custom code	String	
			13 = Order Origination Firm		
→ 452	PartyRole	N	11 = Order Origination Trader	Int	
			See "4.3 - Parties block" for more details		
→ 802	NoPartySubIDs	N	1	NumInGroup	
→→ 523	PartySubID	N	IFTL = Maximum variation of the position	String	
→→	PartySubIDType	N		Int	The content of this field should not

Tag	Name	Req	Valid values	Format	Description
803	End <Parties>				be considered
1	Account	N		String	When not specified: filter applies to the member. If three characters specified: filter applies to the holder.
	Start <Instrument>				
55*	Symbol	Y	[N/A]	String	
48*	SecurityID	Y*	See table 21 in document "Codification Tables" for a list of possible values	String	Underlying asset
22*	SecurityIDSource	Y*	8 = Exchange Symbol	String	
	End <Instrument>				
	Start <Stipulations>				
232*	NoStipulations	N		NumInGroup	
→ 233*	StipulationType	N	MAXVARPOS = Maximum position INIPOS = Initial position	String	When StipulationType [233] = MAXVARPOS, indicates the maximum variation of the position (in absolute value) When StipulationType [233] = INIPOS, indicates Initial position (with sign)
→ 234*	StipulationValue	N		String	
	End <Stipulations>				
506	RegistStatus	Y	A = Accepted R = Rejected	Char	Status of the Registration Instructions request message. If it contains the value "R", there is an explanation for the rejection in the RejectText [1328] field
1328*	RejectText	N		String	If RegistStatus = "R" there is an explanation of the rejection
	Standard Trailer	Y			

9.8 Management of Permissions

Allows the authorised users to define and modify the permissions of each of the users within the member.

As it is explained in section “3.7 - Synchronisation at application level”, when a client initiates a FIX session (Logon message accepted), it receives the Registration Instructions and Registration Instructions Response messages (which indicates the user’s established price filters and when the user has the relevant permissions, those of the other traders of the entity).

9.8.1 List of messages

Message	Description
Registration Instructions (Msg Type = o)	Used by the client to manage the permissions
Registration Instructions Response (Msg Type = p)	Sent by HF MEFFGate to notify or reject the configuration of the permissions

9.8.2 Message flow

Correct request

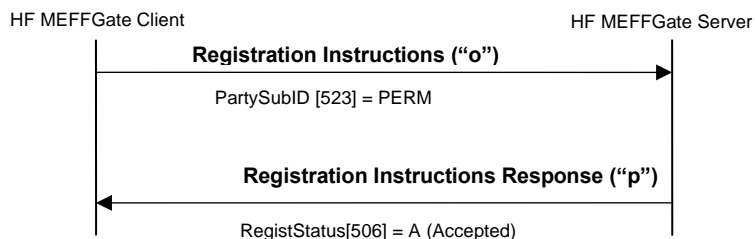

Incorrect request

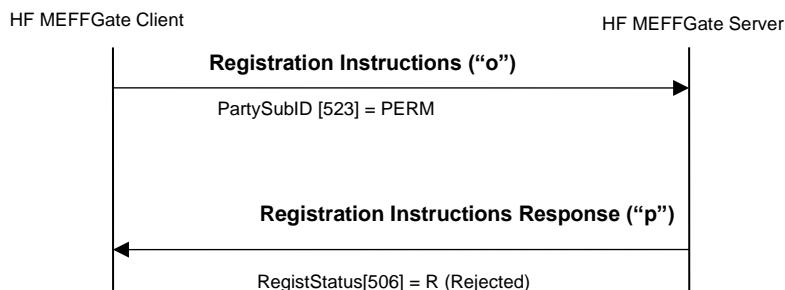

9.8.3 Annotations and adaptations of FIX 5.0

- In the Registration Instructions message, the fields NoPartyIDs [453] and NoPartySubIDs [802] are now required
- The field RejectText [1328] has been added to the Registration Instructions Response message
- The block Stipulations has been added as required to the Registration Instructions message
- The block Stipulations has been added to the Registration Instructions Response message

9.8.4 Definition of messages

9.8.4.1 Registration Instructions (Msg Type = o)

Message sent by the client to manage the configuration of the permissions

Tag	Name	Req	Valid values	Format	Description
	Standard Header	Y	MsgType = o		
513	RegistID	Y	0 = New	String	Unique identifier for each Registration Instructions message
514	RegistTransType	Y	1 = Replace 2 = Cancel	Char	
508	RegistRefID	N		String	Reference identifier for the RegistID (513) with Cancel and Replace RegistTransType (514) transaction types. Required if RegistTransType = 1 or 2
Start <Parties>					
453	NoPartyIDs	Y*		NumInGroup	
→ 448	PartyID	Y*		String	Member and Trader codes which acts this configuration
→ 447	PartyIDSource	Y*	D = Proprietary / Custom code 13 = Order Origination Firm	String	
→ 452	PartyRole	Y*	11 = Order Origination Trader See "4.3 - Parties block" for more details	Int	
→ 802	NoPartySubIDs	Y*	1	NumInGroup	
→→ 523	PartySubID	Y*	PERM = Management of Permissions	String	
End <Parties>					
Start <Stipulations>					
232*	NoStipulations	Y*		NumInGroup	
→ 233*	StipulationType	Y*	ACTION = Code of the action protected by the corresponding permission AUT = Indicates whether or not permission has	String	

Tag	Name	Req	Valid values	Format	Description
			been granted for this action		
→ 234*	StipulationValue	Y*		String	<p>When StipulationType [233] = "ACTION", indicates the code of the action protected by the corresponding permission. See table 29 in document "Codification Tables" for a list of possible values</p> <p>Possible values for StipulationType [233] = "AUT" are:</p> <p>Y - Permission has been granted for this action N - Permission has not been granted for this action</p>
	End <Stipulations>				
	Standard Trailer	Y			

9.8.4.2 Registration Instructions Response (Msg Type = p)

Message used by HF MEFFGate to indicate the status of the request initiated with the Registration Instructions message to manage the configuration of the permissions.

This message is only sent to the user who made the request.

Tag	Name	Req	Valid values	Format	Description
	Standard Header	Y	MsgType = p		
1180	ApplID	N		String	Used in conjunction with ApplSeqNum [1181] to indicate, in subsequent connections, the point from which to receive information
1181	ApplSeqNum	N		SeqNum	Used in conjunction with ApplID [1180] to indicate, in subsequent connections, the point from which to receive information
513	RegistID	Y		String	Identifier assigned by the client in the Registration Instructions message
			0 = New		
514	RegistTransType	Y	1 = Replace 2 = Cancel	Char	
508	RegistRefID	N		String	Identifier of Registration Instructions message which is replaced or cancelled by this message. Included when RegistTransType = 1 or 2
	Start <Parties>				
453	NoPartyIDs	N		NumInGroup	
→ 448	PartyID	N		String	Member and Trader codes which acts this configuration
→ 447	PartyIDSource	N	D = Proprietary / Custom code	String	
			13 = Order Origination Firm		
→ 452	PartyRole	N	11 = Order Origination Trader See "4.3 - Parties block" for more details	Int	
→ 802	NoPartySubIDs	N	1	NumInGroup	
→→ 523	PartySubID	N	PERM = Management of Permissions	String	
→→ 803	PartySubIDType	N		Int	The content of this field should not be considered
	End <Parties>				
	Start				

Tag	Name	Req	Valid values	Format	Description
<Stipulations>					
232*	NoStipulations	N		NumInGroup	
→ 233*	StipulationType	N	ACTION = Code of the action protected by the corresponding permission AUT = Indicates whether or not permission has been granted for this action	String	
→ 234*	StipulationValue	N		String	When StipulationType [233] = "ACTION", indicates the code of the action protected by the corresponding permission. See table 29 in document "Codification Tables" for a list of possible values Possible values for StipulationType [233] = "AUT" are: Y - Permission has been granted for this action N - Permission has not been granted for this action
End <Stipulations>					
506	RegistStatus	Y	A = Accepted R = Rejected	Char	Status of the Registration Instructions request message. If it contains the value "R", there is an explanation for the rejection in the RejectText [1328] field
1328*	RejectText	N		String	If RegistStatus = "R" there is an explanation of the rejection
Standard Trailer		Y			

10 Quote management

10.1 Introduction

Quote management covers various functions. From the perspective of a FIX client these are:

- Configuration of the quote parameters: Account and delta protection
- Enter quotes
- Modify quotes
- Cancel quotes
- Notification of quote execution

There is a separate section on each of these functions in this chapter. There is a description of the method of use, the list of related messages, the message flow and the additions or annotations incorporated in this implementation for each function. At the end of the chapter there is a detailed description of all the messages included in the chapter.

10.2 Configuration of the quote parameters: Account configuration and MiFiD II tags and delta protection

10.2.1 Introduction

The FIX client uses this function to configure the values used by the HF MEFFGate in the delta protection configuration and the account and MiFiD II tags for quotes used in the Quote message.

10.2.2 Description

In order to enter quotes is mandatory to define by the FIX client, for the futures and options of each underlying asset, the account and MiFiD II tags (to be applied for the next quotes) and the delta protection.

These parameters are only valid for the current trading session. The FIX client must send these information everyday.

If these parameters are not defined, HF MEFFGate will reject the quote with the corresponding error message.

When the account or the MiFiD II tags are modified, the new values are only for the next quotes with the same priority order rules.

For delta protection and account configuration and MiFiD II tags for quotes, see chapter "9.3 - Delta protection + Account configuration and MiFiD II tags for quotes".

For message flow and definition of messages, see chapters 0 and 9.3.4.

10.3 Enter quotes

10.3.1 Description

The FIX client uses this function to enter quotes in the trading system

Only one quote per security per every FIX client is allowed. If a second quote for the same security is entered, HF MEFFGate will cancel the old quote and will accept (or reject) the new one. HF MEFFGate will never send a cancellation for a previous quote, therefore the client application should interpret receiving a Quote Status Report, be it an acceptance or rejection, as implying the cancellation of the previous quote for this security.

The client application can send a partial quote (only the buy side or the sell side). In this event, only the corresponding side should be filled (BidPx/BidSize o OfferPx/OfferSize) and in the other side zero volume will be assumed and any previous notification will be cancelled.

Once a quote has been accepted, it can be modified, cancelled or executed. These subjects are covered in detail in other sections of this chapter.

The client application must be ready to receive a quote accepted only on one side (buy or sell) and rejected on the other one (for instance due to the price limits).

In the event of any disconnection, the central system will automatically cancel the pending quotes.

10.3.2 List of messages

Message	Description
Quote (Msg Type = S)	Used by the client to enter a new quote
Quote Status Report (Msg Type = AI)	Sent by HF MEFFGate, as reply to a Quote message, to confirm or reject the new quote

10.3.3 Message flow

A single quote entry (using Quote message) totally accepted by HF MEFFGate and central systems

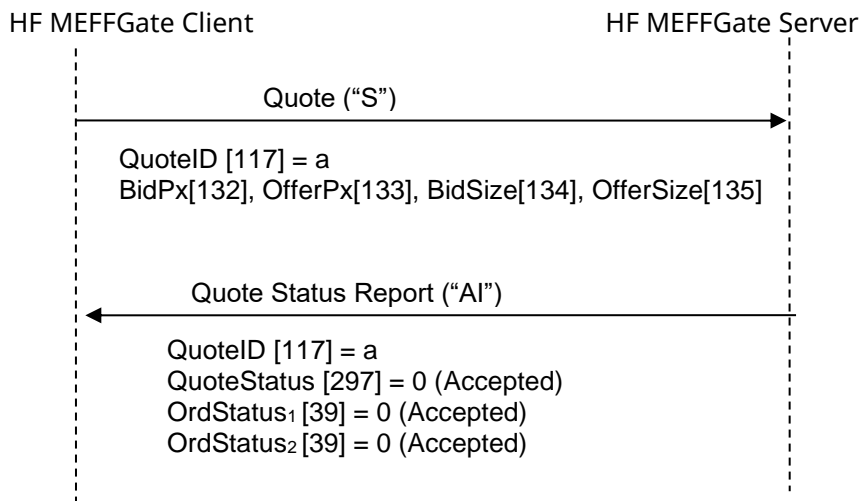

New quote entry (using Quote message) partially accepted by central host

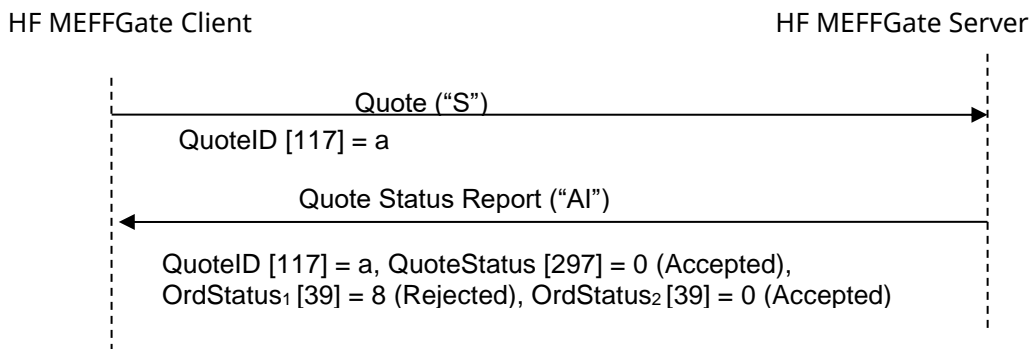

New partial quote entry (sell-sided only) totally accepted by HF MEFFGate and central

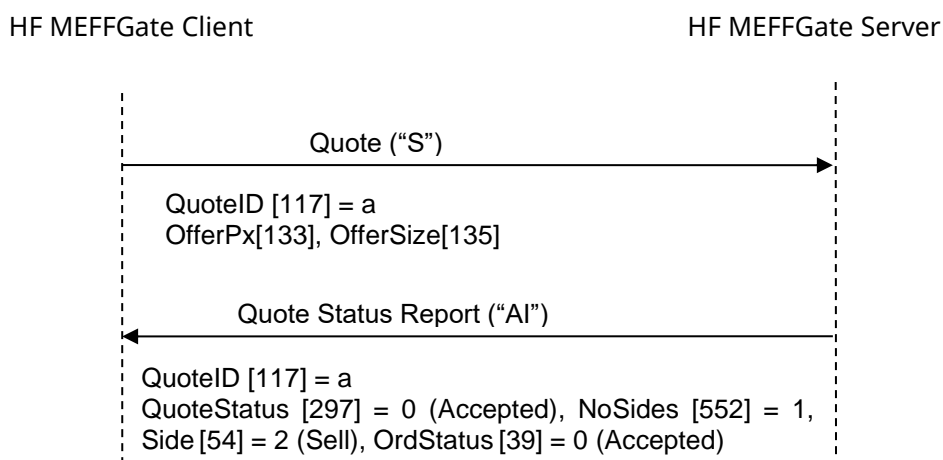

Quote message rejected by HF MEFFGate

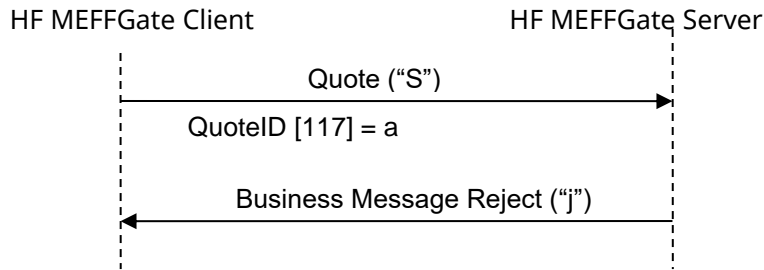

A second correct quote is entered for the same security (MEFF system automatically cancels the first quote and accepts the second one)

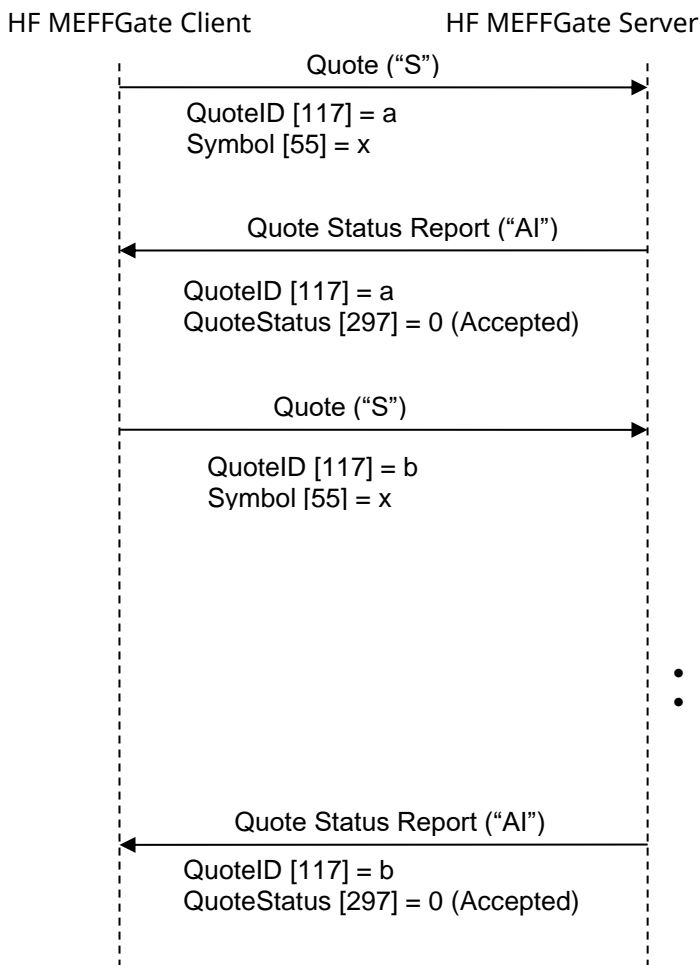

- Quote with QuoteID [117] = a cancelled
- Quote with QuoteID [117] = b accepted

A second erroneous quote, rejected by the MEFF central system, is entered for the same security (MEFF system automatically cancels both quotes)

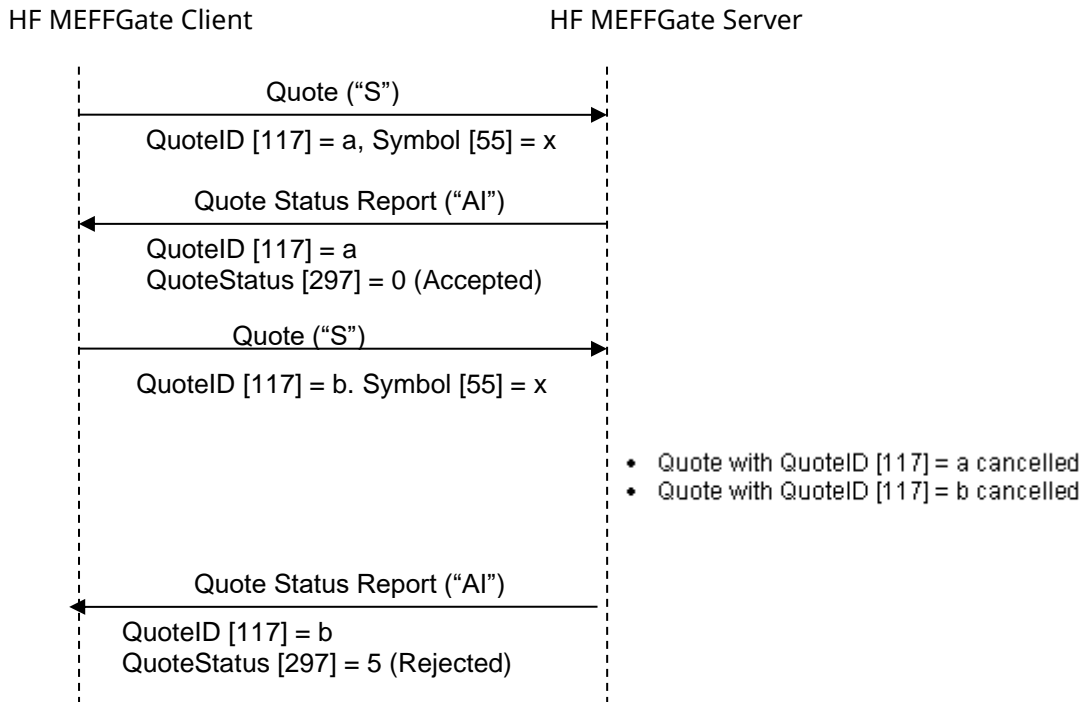

ReceivePendings [5678] (Logon) = Y: New quote entry totally accepted by HF MEFFGate and central systems

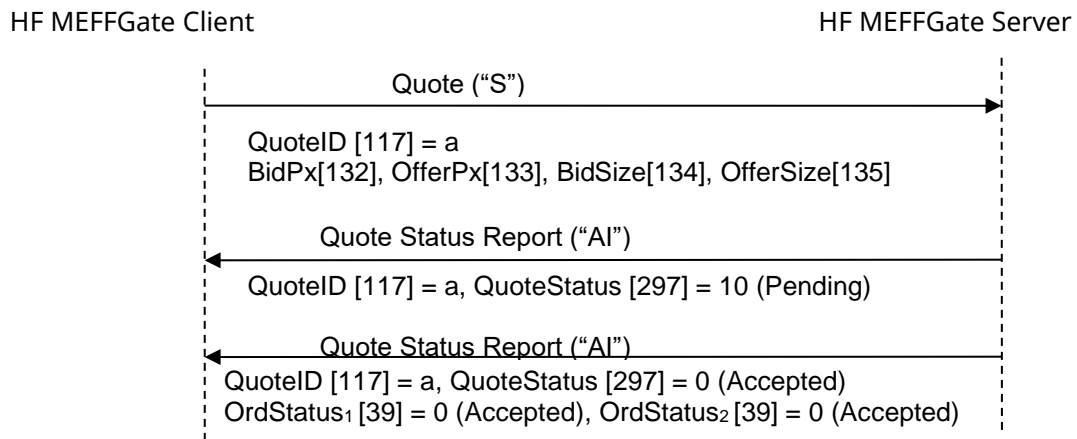

10.3.4 Annotations and adaptations of FIX 5.0

- The optional fields: NoSides [552], Side [54], SecondaryOrderID [198], SecondaryExecID [527], OrdStatus [39], OrdRejReason [103], LeavesQty [151], ApplID [1180] and ApplSeqNum [1181] have been added to the Quote Status Report message

10.4 Modify quotes

10.4.1 Description

When a quote has been accepted it is possible to modify various attributes

The following quote attributes can be modified on MEFF:

- Bid price
- Ask price

The modification request is done by using the Quote message with the same QuoteID identifier used for the quote to be modified.

As a general rule the fields specified in the modification request substitute the previous values. The fields not specified remain unchanged.

A quote modification rejected by MEFF central systems means that the MEFF system automatically cancels the existing quote. As in the quote entry, HF MEFFGate will never send a cancellation for a previous quote, therefore the client application should interpret receiving a Quote Status Report, be it an acceptance or rejection, as implying the cancellation of the previous quote for this security.

A quote modification follows the same priority rules applied to limit orders.

10.4.2 List of messages

Message	Description
Quote (Msg Type = S)	Used by the client to enter a quote modification
Quote Status Report (Msg Type = AI)	Sent by MEFF to confirm or reject the quote modification

10.4.3 Message flow

Quote modification rejected by HF MEFFGate

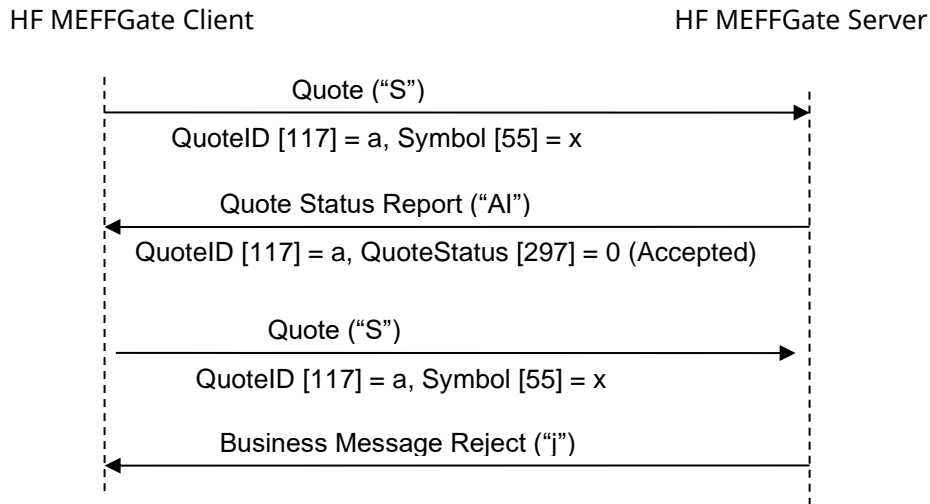

Quote modification accepted by HF MEFFGate and central systems

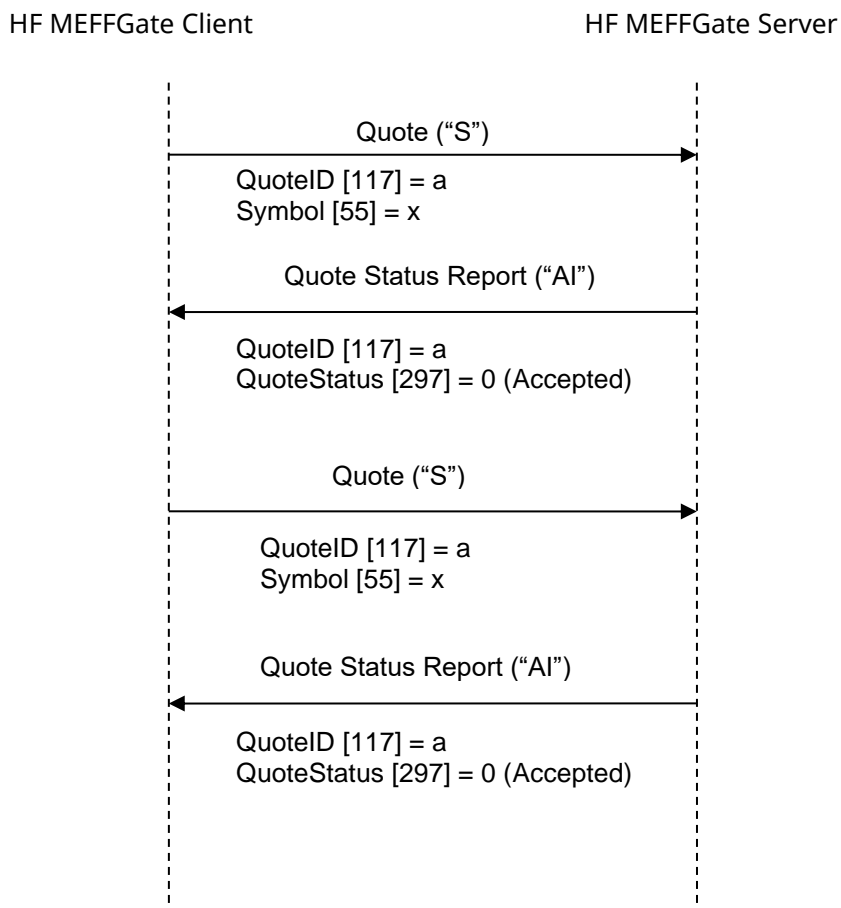

Quote modification rejected by the MEFF central system (MEFF system automatically cancels the existing quote)

HF MEFFGate Client

HF MEFFGate Server

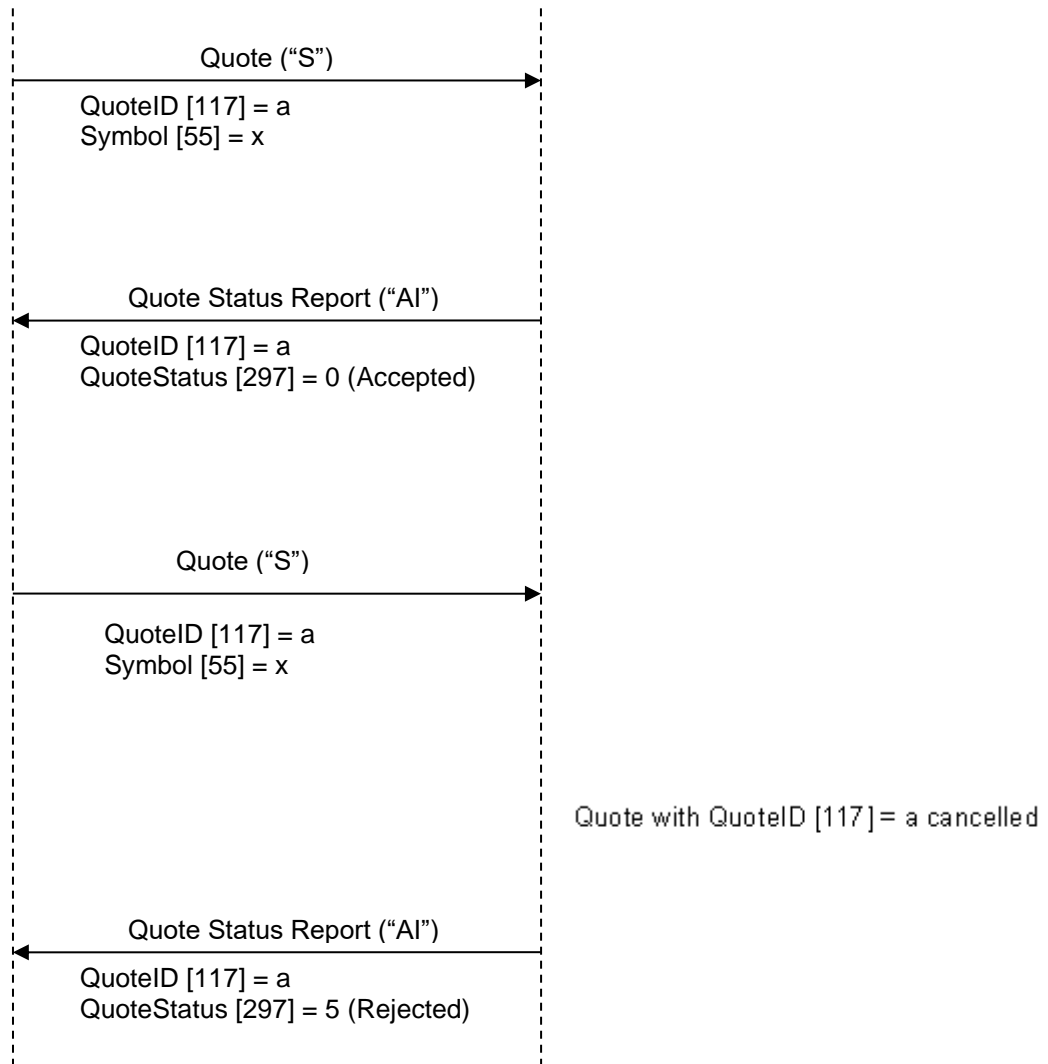

ReceivePendings [5678] (Logon) = Y: Quote modification accepted by HF MEFFGate and central systems

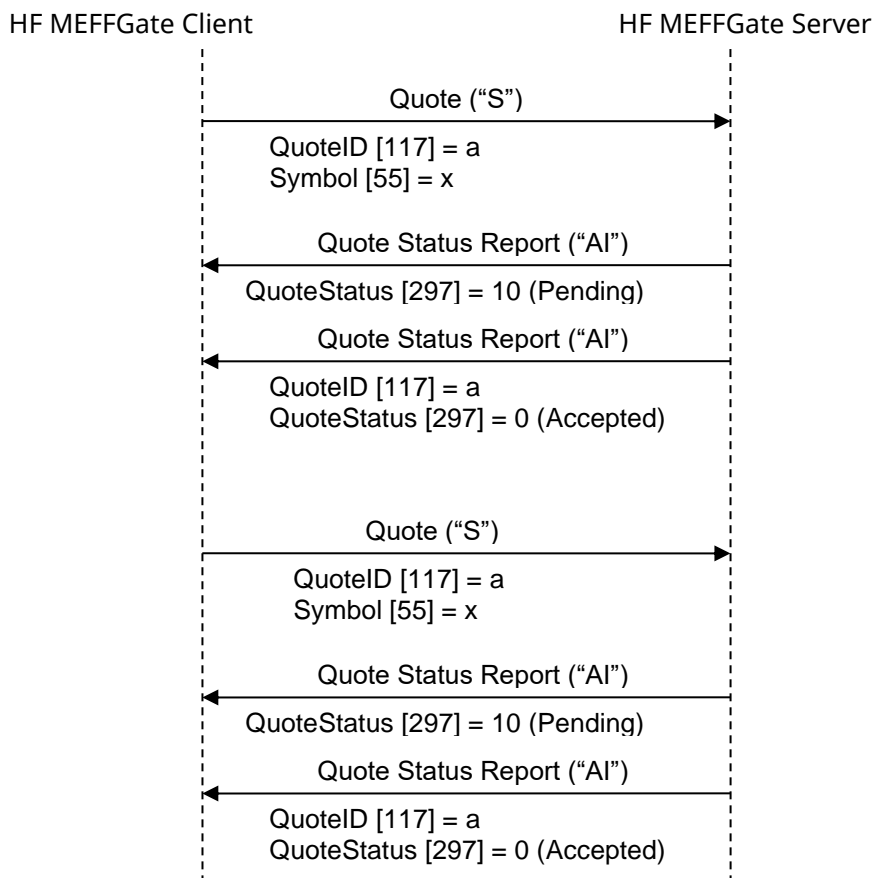

10.4.4 Annotations and adaptations of FIX 5.0

- The optional fields: NoSides [552], Side [54], SecondaryOrderID [198], SecondaryExecID [527], OrdStatus [39], OrdRejReason [103], LeavesQty [151], ApplID [1180] and ApplSeqNum [1181] have been added to the Quote Status Report message

10.5 Cancel quotes

10.5.1 Description

This function allows:

- a) To cancel a single quote or
- b) to cancel a group of quotes with a single instruction

To cancel a single quote the Quote message (Msg Type = S) should be used specifying the security code for the quote to be cancelled and the price and volume fields filled to zero (BidPx, OfferPx, BidSize and OfferSize).

To cancel block of quotes the Quote Cancel message (Msg Type = Z) should be used specifying the selection criteria

10.5.2 Selection criteria

The selection criteria for quotes to be cancelled provided by MEFF (using the Quote Cancel message), as described in 4.4, are the following:

- **Symbol [55]**
- **SecurityType [167]**
- **SecurityID [48]**
- **MaturityMonthYear [200]**

When various criteria are used to make a selection, only the quotes that meet all the criteria will be selected.

Selection criteria that are not used will be ignored when selecting quotes. If no selection criteria are specified all quotes will be included.

10.5.3 List of messages

Message	Description
Quote (Msg Type = S)	Used by the client to cancel a single quote
Quote Cancel (Msg Type = Z)	Used by the client to cancel quotes that meet selection criteria
Quote Status Report (Msg Type = AI)	Message sent by HF MEFFGate to accept or reject one or various quote cancellations

10.5.4 Message flow

Mass cancellation quote request accepted

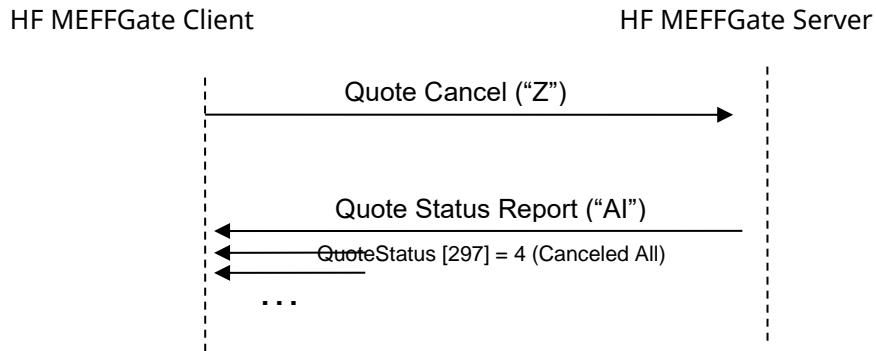

Individual cancellation quote request accepted

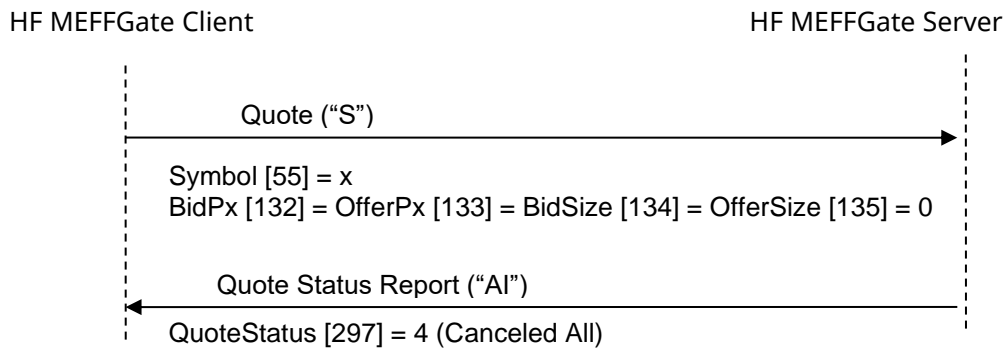

Cancellation quote request rejected

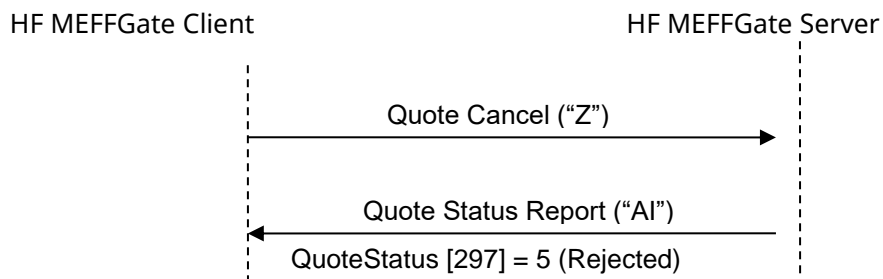

ReceivePendings [5678] (Logon) = Y: Mass cancellation quote request accepted

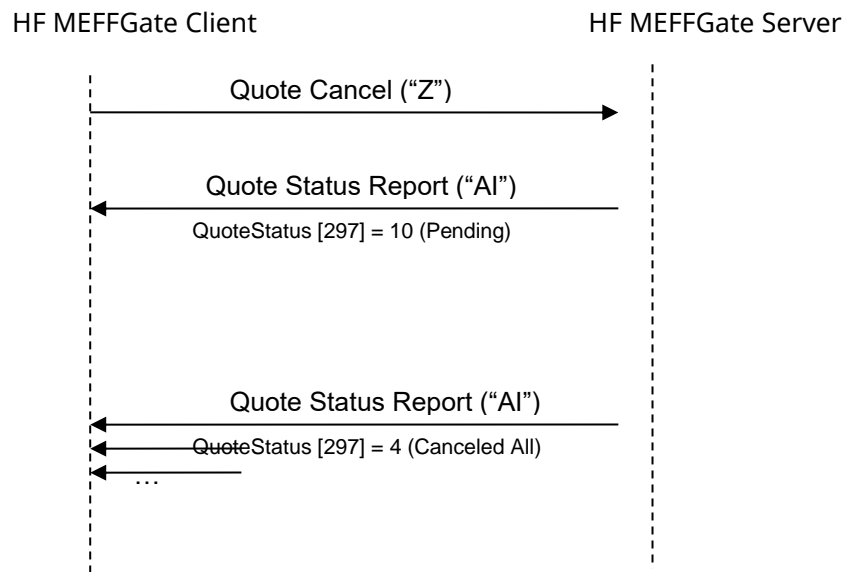

10.5.5 Annotations and adaptations of FIX 5.0

- The optional fields Quote Status Report: NoSides [552], Side [54], SecondaryOrderID [198], SecondaryExecID [527], OrdStatus [39], OrdRejReason [103], LeavesQty [151], ApplID [1180] and ApplSeqNum [1181] have been added to the Quote Status Report message

10.6 Notification of quote execution

10.6.1 Description

When a quote is filled or partially filled, HF MEFFGate sends an Execution Report message to notify this, where the field ExecType [150] = "F" (Trade).

10.6.2 List of messages

Message	Description
Execution Report (Msg Type = 8) (ExecType = F)	Sent by HF MEFFGate to notify the quote has been filled or partially filled

10.6.3 Message flow

Notification of execution

The client receives the Execution Report message for each partial fill or complete fill of a quote.

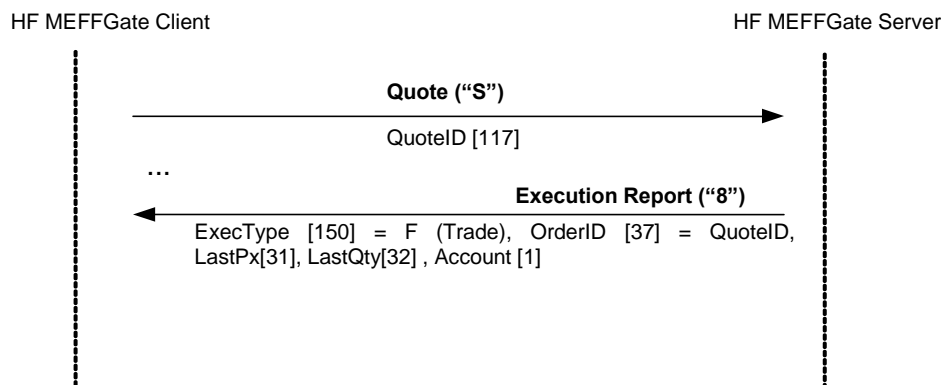

10.6.4 Annotations and adaptations of FIX 5.0

No annotations or adaptations have been made to the messages in this chapter.

10.7 Quote Status Request

10.7.1 Description

This query related to a single quote information is made by means of the Quote Status Request message

The types of information offered by MEFF are:

- **Instrument.** Allows querying a quote on a certain type of security

10.7.2 List of messages

Message	Description
Quote Status Request (Msg Type = a)	Status request for a single quote
Quote Status Report (Msg Type = AI)	Information on the quote status, or notification of error in request

10.7.3 Message flow

Quote status request

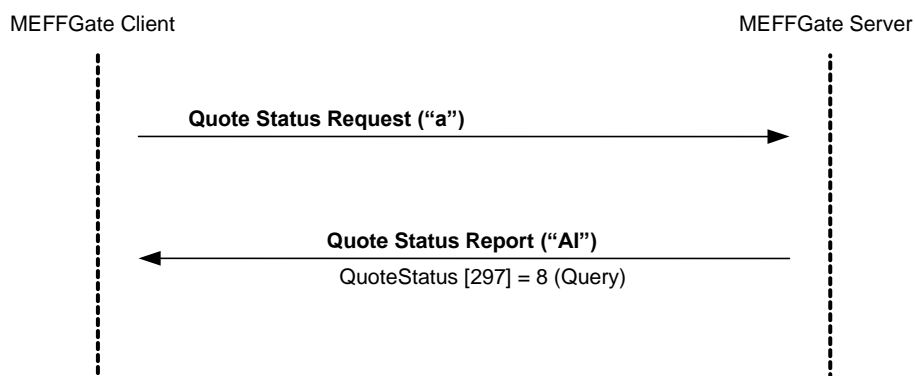

Quote status request failed

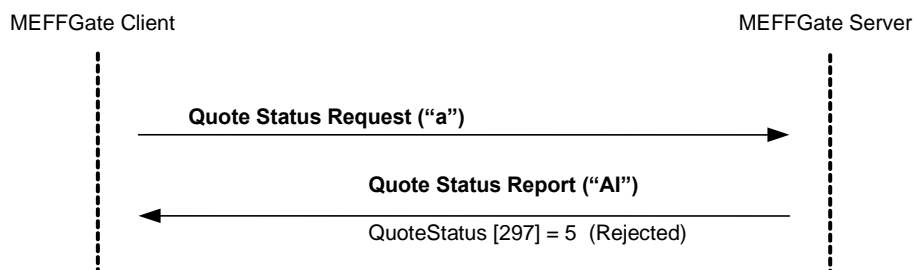

10.7.4 Annotations and adaptations of FIX 4.4

In the Quote Status Request message, the QuoteStatusReqID [649] field is now required

10.8 Definition of messages

10.8.1 Quote (Msg Type = S)

Message sent by client to enter, modify or cancel a quote in the system

Tag	Name	Req	Valid values	Format	Description
	Standard Header	Y	MsgType = S		
					Unique quote identifier.
117	QuoteID	Y		String (10)	When it is a modification this field contains the quote identifier as in the original quote
	Start <Instrument>				Contract code
55	Symbol	Y	Contract code	String(22)	When it is a modification or cancellation this field should contain the same value as in the original quote
	End <Instrument>				
					Bid price.
132	BidPx	N		Price	In a modification, if not specified, this field remains unchanged. In a cancellation it should contain zero
					Ask price.
133	OfferPx	N		Price	In a modification, if not specified, this field remains unchanged. In a cancellation it should contain zero
					Bid volume.
134	BidSize	N		Qty	In a modification this field must not be included. In a cancellation it should contain zero
					Ask volume.
135	OfferSize	N		Qty	In a modification this field must not be included. In a cancellation it should contain zero
	Standard Trailer	Y			

10.8.2 Quote Cancel (Msg Type = Z)

Message sent by the client to request the cancellation of quotes that meet certain selection criteria.

Tag	Name	Req	Valid values	Format	Description
	Standard Header	Y	MsgType = Z		
117	QuoteID	Y		String (10)	Unique identifier of this Quote Cancel Status Request message
298	QuoteCancelType	Y	4 = Cancel All Quotes	Int	
	Start <Parties>				
453	NoPartyIDs	N		NumInGroup	
→ 448	PartyID	N		String	Member or Trader code whose quotes are to be cancelled
→ 447	PartyIDSource	N	D = Proprietary/ Custom code	Char	Required if NoPartyIDs is specified
→ 452	PartyRole	N	13 = Order Origination Firm 11 = Order Origination Trader	Int	Indicates the role taken by the code specified in PartyID. Required if NoPartyIDs is specified
	End <Parties>				
295	NoQuoteEntries	N	1	NumInGroup	
	Start <Instrument>				
→ 55	Symbol	Y	[N/A] or contract code	String(22)	Contract code. If it is "[N/A]" the quotes for all contracts matching the rest of criteria will be selected
→ 48	SecurityID	N	See table 21 in document "Codification Tables" for a list of possible values	String	Underlying asset
→ 22	SecurityIDSource	N	8 = Exchange Symbol	String	Required if SecurityID is specified
→ 167	SecurityType	N	See table 31 of document "Codification Tables" for details of the Trade Type codes	String	Product type
→ 200	MaturityMonthYear	N	YYYYMM or YYYYMMDD or YYYYMMwW	Month-Year	Contract expiration
	End <Instrument>				
	Standard Trailer	Y			

10.8.3 Quote Status Request (Msg Type = a)

Message sent by the client to request status for a single quote

Tag	Name	Req	Valid values	Format	Description
	Standard Header	Y	MsgType = a		
649	QuoteStatusRe qID	Y*		String(10)	Message identifier
	Start <Instrument>				
55	Symbol	Y	Contract code	String(22)	Contract code
	End <Instrument>				
	Standard Trailer	Y			

10.8.4 Quote Status Report (Msg Type = AI)

Sent by HF MEFFGate to notify the status for a single quote. It also notifies whether the request is accepted or rejected.

Tag	Name	Req	Valid values	Format	Description
	Standard Header	Y	MsgType = AI		
649	QuoteStatusReqID	N		String	It contains the same value as specified in the related Quote Status Request. Only filled if the Quote Status Report is a consequence of a Quote Status Request.
117	QuoteID	Y		String	QuoteID sent by the client in the Quote message
537	QuoteType	N	1 = Tradeable	Int	
	Start <Parties>				
453	NoPartyIDs	N		NumInGroup	
→ 448	PartyID	N		String	Member or Trader code
→ 447	PartyIDSource	N	D = Proprietary/ Custom code	Char	
→ 452	PartyRole	N	13 = Order Origination Firm 11 = Order Origination Trader	Int	Indicates the role taken by the code specified in PartyID. Required if NoPartyIDs is specified
	End <Parties>				
	Start <Instrument>				
55	Symbol	Y	Contract code	String(22)	Contract code for this quote
48	SecurityID	N		String(12)	ISIN security code
22	SecurityIDSource	N	4 = ISIN Number	String	
	End <Instrument>				
1	Account	N	Fixed length	String(5)	Account code for this quote
132	BidPx	N		Price	Bid price of the quote, as indicated in the Quote message
133	OfferPx	N		Price	Ask price of the quote, as indicated in the Quote message
134	BidSize	N		Qty	Bid volume of the quote, as indicated in the Quote message
135	OfferSize	N		Qty	Ask volume of the quote, as indicated in the Quote message
60	TransactTime	N		UTCTimestamp	Time when transaction represented by this Quote Status Report occurred. This field is not present when

Tag	Name	Req	Valid values	Format	Description
			0 = Accepted		QuoteStatus is equal to 10
297	QuoteStatus	N	4 = Canceled All 5 = Rejected 8 = Query 10 = Pending	Int	Indicates the quote status. If rejected (value 5), there is an explanation in the RejectText [1328] field
1328	RejectText	N		String	If QuoteStatus [297] = 5 (Rejected) there is an explanation of the rejection
552*	NoSides	N	1, 2	NumInGroup	
→ 54*	Side	N	1 = Buy 2 = Sell	Char	
→198*	SecondaryOrderID	N		String	Identifier per side of the quote (one for the buyer and a different one for the seller), assigned by central system of MEFF
→527*	SecondaryExecID	N		String	Quote side history number, assigned by central system of MEFF. Each time there is a new event in the life of the quote side (modification, trade or cancellation) is assigned a new value to this field.
→39*	OrdStatus	N	0 = New 1 = Partially Filled 2 = Filled 4 = Cancelled 6 = Pending Cancel 8 = RejectedA = Pending New E = Pending Replace	Char	Indicates the current status of the buy side or the sell side of the quote
→103*	OrdRejReason	N	See codification table 11	Int	Rejection or cancellation motive. Present when OrdStatus [39] = 4 or 8
→151*	LeavesQty	N		Qty	Quote volume pending of the buy side or the sell side of the quote. Contains 0 when OrdStatus [39] = 4 (Cancelled)
	Start <Stipulations>				

Tag	Name	Req	Valid values	Format	Description
→232 *	NoStipulations	N		NumInGroup	
→→23 3*	StipulationType	N	LATENCY = Indicator of having been in latency protection RTS24_21 = Event according to field 21 RTS 24	String	<p>When StipulationType [233] = LATENCY, the valid values are:</p> <ul style="list-style-type: none"> • Y = Yes. The quote side (buy or sell) has been in latency protection. • N = No (default). The quote side (buy or sell) has not been in latency protection. <p>If this field is not reported it means that the quote side (buy or sell) has not been in latency protection.</p> <p>When StipulationType [233] = RTS24_21:</p> <ul style="list-style-type: none"> • NEWO – New order • REME – Replaced by initiative of message receiver • REMA – Replaced by Market Surveillance (automatic) • REMH – Replaced by Market Surveillance (manual) • CAME – Cancellation by initiative of message receiver • CAMO – Cancellation by Surveillance • REMO – Rejection • EXPI – Order expired • PARF – Partial fill • FILL – Filled • CHME – Change of status at the initiative of the member/participant of the trading venue • CHMO – Change of status due to market operations
→→23 4*	StipulationValue	N			
	End <Stipulations>				
1180*	ApplID	N		String	Used in conjunction with ApplSeqNum [1181] to indicate, in subsequent connections, the point from which to receive information

Tag	Name	Req	Valid values	Format	Description
1181*	ApplSeqNum	N		SeqNum	Used in conjunction with ApplID [1180] to indicate, in subsequent connections, the point from which to receive information
	Standard Trailer	Y			

11 Cross trades

11.1 Introduction

This chapter describes the mechanisms offered by MEFF FIX interface to manage the cross trades.

This functionality allows members to request the registration of these cross trades on MEFF.

In the cross trades between different members there are typically involved two members: one buy side and one sell side. They are entered in the system by one of the two members or an executing broker. The cross trade must be explicitly accepted by both the buy side and sell side members, furthermore, in certain circumstances, the Market Supervisor may also have to accept the cross trade.

To request the register for a cross trade, the message Trade Capture Report is used.

Client systems of the HF MEFFGate will receive a Trade Capture Report for each cross trade to be confirmed. It is not necessary to send as a response a Trade Capture Report Ack message; these messages are ignored by the MEFFGate. The client system can reject or accept a cross trade. When accepting the cross trade, the client code to which the cross trade is to be assigned has to be informed.

Each time a modification in the state of a cross trade is effected, HF MEFFGate, using a Trade Capture Report, will notify each of the parties involved: the buyer, the seller and, if present, the executing broker. Note that, HF MEFFGate only informs of the client account code or the reference to the interested parties (the buy side or sell side)

Some cross trades, having been accepted by both parties, will need to be accepted also by Market Supervision. When Market Supervision accepts or rejects the cross trades, all the parties will receive a notification.

Some cross trades may be pending collateral arrangements by a member. The system will notify this circumstance to the interested party.

Note that, for those cross trades which are in the end accepted, an Execution Report will be generated for each of the counterparties.

11.2 Entry of cross trades between different members

There are three parties involved in these cross trades: the buyer and the seller in the cross trade, and the broker that sends the cross trade to HF MEFFGate. These cross trades are notified to HF MEFFGate using the Trade Capture Report message. Each of the parties is identified by the member and trader code.

To identify a non-standard (flexible) contract, tag FlexibleIndicator [1244] should be informed and also the following combination should be used in the cross trade functionality: SecurityType [167] + PutOrCall [201] + SettlementMethod [1193] + ExerciseStyle [1194] + EventText [868] when EventType [865] = 134 + SecurityID [48] + MaturityDate [541] + ContractMultiplier [231] + StrikePrice [202]. In this case, where appropriate, the central system will assign a new code following the existing rules and will populate these fields in the Trade Capture Report message.

Once the cross trade has been sent to HF MEFFGate, it can be cancelled or modified by the sender, providing that it has not yet been accepted by any of the parties.

Both the buyer and the seller can act as brokers, as well as an external member. This means there are four possible scenarios:

Scenario	Identification of the parties in the message
Broker, buyer and seller are different members	SenderCompID = Broking member code
	SenderSubID = Broking trader code
	Buyer PartyID = Buying member code
	Buyer PartySubID = Buying trader code
The buyer acts as broker	Seller PartyID = Selling member code
	Seller PartySubID = Selling trader code
	SenderCompID = Buying member code
	SenderSubID = Buying trader code
The seller acts as broker	Buyer PartyID = Buying member code
	Buyer PartySubID = Buying trader code
	Seller PartyID = Selling member code
	Seller PartySubID = Selling trader code
The same member acts as buyer, seller and broker	SenderCompID = Member code
	SenderSubID = Trader code
	Buyer PartyID = Buying member code
	Buyer PartySubID = Buying trader code
	Seller PartyID = Selling member code
	Seller PartySubID = Selling trader code

See 3.3 for more information on the use of the SenderCompID and SenderSubID fields.

11.3 Acceptance of cross trades between different members

If the cross trade is finally accepted and executed, both the buyer and the seller receive the corresponding Execution Report messages (ExecType = F, Trade) notifying them of the execution of the cross trade. These messages will have the trader code corresponding to the one who accepted the cross trade. The CrossID field of the Execution Report message contains the SecondaryTradeReportID value assigned by the central host.

As previously explained, when the cross trade is accepted and executed, the intermediary receives a Trade Capture Report message

The Execution Report message allows the broker of the cross trade to be identified using the Entering Firm and Entering Trader roles in the Parties block (see 4.3 for more information on the Parties block).

11.4 Entry of cross trades within the member

In this situation the confirmation for the sides involved is not necessary.

11.5 Price and Effective amount

The field GrossTradeAmt [381] indicates the effective amount. If informed, this value will be used instead of the rounded price.

The System will determine the transaction price according to:

$$\text{Precio}_{trans} = \frac{\text{Effective_amount}}{\text{Volume} \bullet \text{multiplier}}$$

and will be verified that this value Precio_trans is commensurate with the rounded price furnished by the client application in the field LastPx [31] of the Trade Capture Report message. If not, the cross trade will be rejected.

11.6 Cross trade groups and cash market cross trades

Tag TradeLinkID [820] allows for the grouping of different cross trades on the same underlying into one single cross trade group.

In this case, one of the trades may refer to the underlying contract. If this may be traded in the equities trading platform, the cash market cross trade will be notified to the MEFF members and the equities trading platform members (Authenticating Member) who will be person responsible for accepting or rejecting it. The final acceptance of the cash market cross trade is subject to the acceptance of some of the corresponding derivatives cross trades.

11.7 Cross trade rejected by the System

In this version of T5.4 protocol, all system rejections are homogenized and are always done in the same way: sending a Business Message Reject message. As a consequence, value B is not longer used in field MatchType [574]

11.8 List of messages

Message	Description
Trade Capture Report (Msg Type = AE)	Sent to HF MEFFGate to initiate, accept, reject or cancel a trade request about block trading or special operations. Sent by HF MEFFGate to request the acceptance or rejection by the parties

A cross trade accepted (The buyer and the seller are the same member)

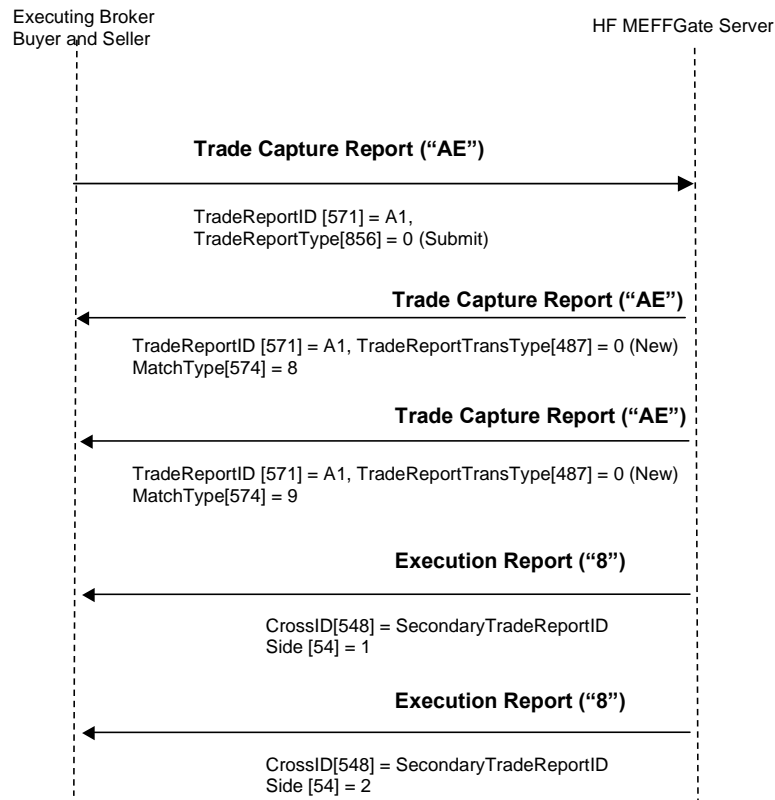

Cross trade request in Derivatives (entered by a member different than the buyer or the seller)

The following diagram shows the message flow of a cross trade request entered by the Executing Broker, accepted first by the buy side and then by the sell side. Once the cross trade has been accepted by the Supervisor, the parties receive the corresponding Executing Report.

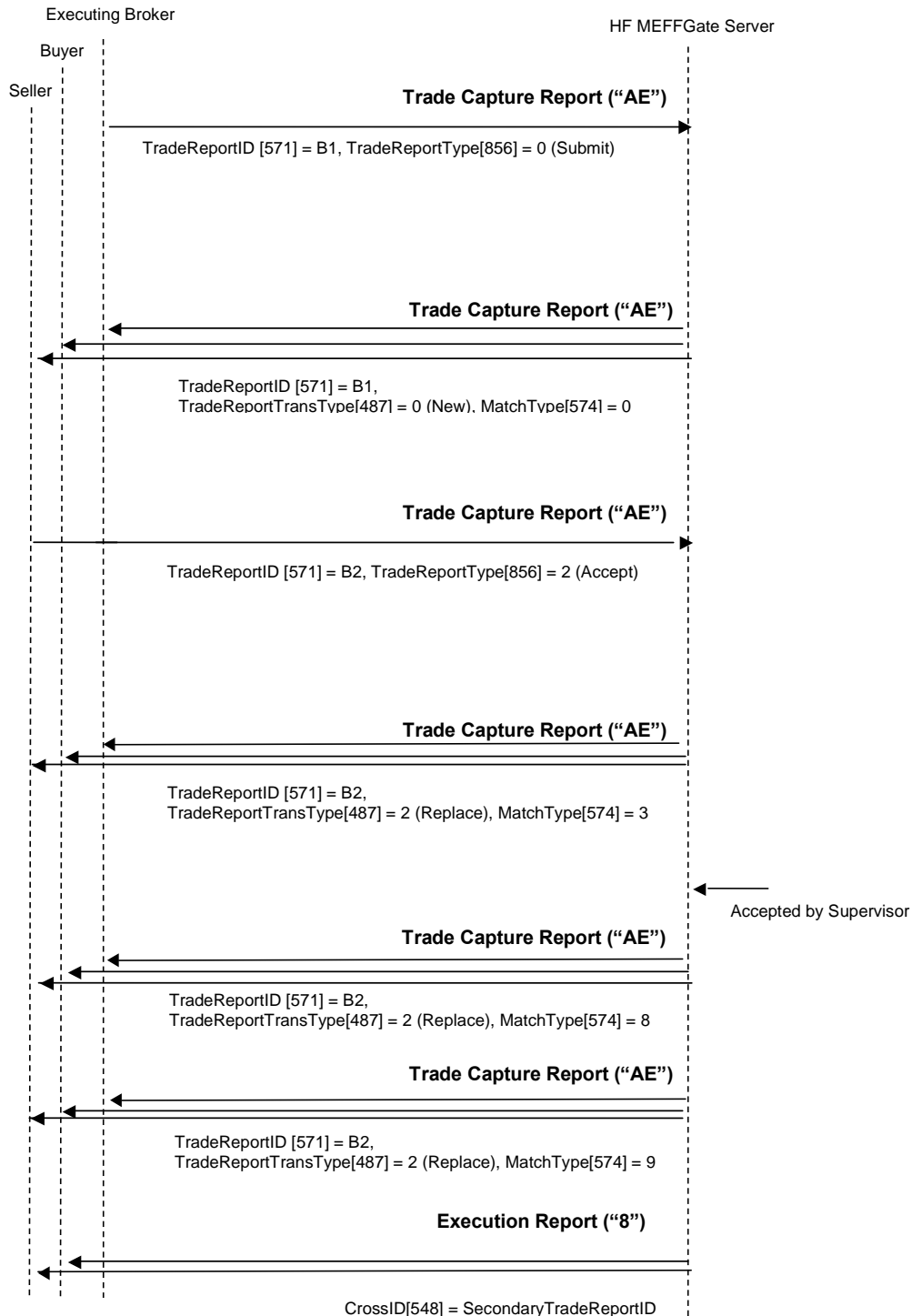

Cash market cross trades request

In this message flow it appears the figure of the Authenticating Firm, who accepts the transaction (in its buying or selling side). The buyer and seller receive information on the status of implementation at all times.

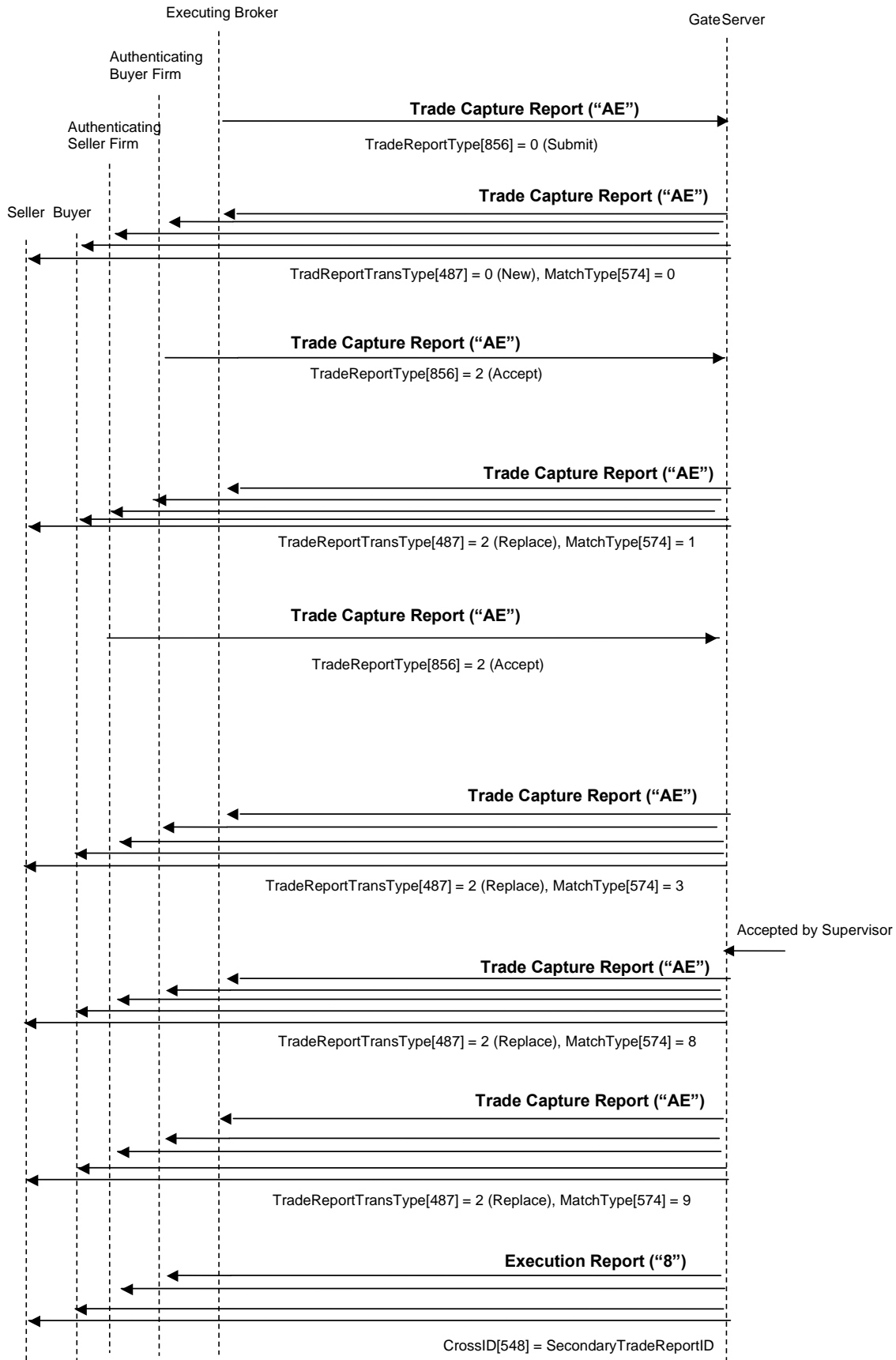

Cross trade rejected by the System

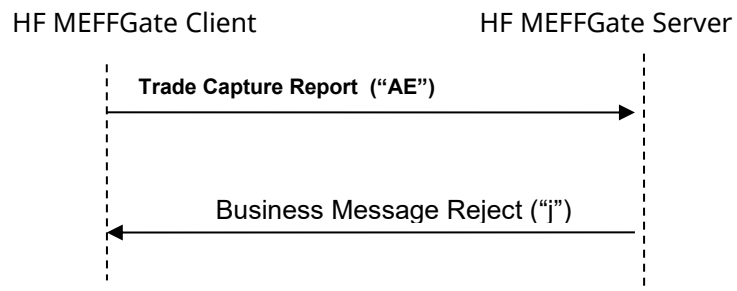

11.10 Annotations and adaptations of FIX 5.0

- In the Trade Capture Report sent to HF MEFFGate message, the TradeReportType [856], TrdType [828] and TrdSubType [829] fields are now required

11.11 Definition of messages

11.11.1 Trade Capture Report (Msg Type = AE) sent to HF MEFFGate

Message containing data for the registering on a trade.

Tag	Name	Req	Valid values	Format	Description
	Standard Header	Y	MsgType = AE		
571	TradeReportID	Y		String (10)	Unique identifier for each Trade Capture Report message sent to HF MEFFGate. Unique per FIX session.
					Type of Trade Report.:
			0 = Submit		0 (Submit): This is the value indicated by the initiator when he sends the initial cross trade request
856	TradeReportType	Y*	2 = Accept 3 = Decline 6 = Trade Report Cancel	Int	2 (Accept): Used by one counterparty to accept a cross trade 3 (Decline): Used by one counterparty to reject a cross trade 6 (Cancel): This is the value to indicate by the initiator to cancel the initial cross trade request
828	TrdType	Y*	See table 19 of document "Codification Tables" for details of the Trade Type codes	Int	Trade type. This value is used in conjunction with TrdSubType [829]
829	TrdSubType	Y*	See table 19 of document "Codification Tables" for details of the Trade Type codes	Int	This value is used in conjunction with TrdType [828]
					Required except for the initial cross trade request.
881	SecondaryTradeReportRefID	N		String	It must contain the value received from MEFFGate in the field SecondaryTradeReportID [818] of the Trade Capture Report or Trade Capture Report Ack messages.

Tag	Name	Req	Valid values	Format	Description
					This is the cross trade request unique identifier through its whole life.
820	TradeLinkID	N		String	Used by the HF MEFFGate client to associate a group of cross trades together
	Start <Instrument>				
55	Symbol	Y	Contract code, [N/A]	String(22)	Contract code or [N/A]
48	SecurityID	N	See table 21 in document "Codification Tables" for a list of possible values	String	Underlying asset
22	SecurityIDSource	N	8 = Exchange symbol	String	Required if SecurityID [48] is present.
167	SecurityType	N	See table 31 of document "Codification Tables" for details of the Trade Type codes	String	Product type
541	MaturityDate	N		LocalMktDate	Expiration date
202	StrikePrice	N		Price	Exercise price. Only present for options
231	ContractMultiplier	N		Float	Conversion factor between price units and monetary units
1193	SettlMethod	N	C = Cash settlement required P = Physical settlement required	Char	Settlement method for this security
1194	ExerciseStyle	N	0 = European 1 = American	Int	Type of exercise of this security
201	PutOrCall	N	0 = Put 1 = Call	Int	Indicates whether an option contract is a put or call
1244	FlexibleIndicator	N	Y = Flexible N = Standard (default)	Boolean	Used to indicate if this security has been defined as flexible according to "non-standard" means. When not informed, means "N = Standard "
864	NoEvents	N		NumInGroup	
→865	EventType	N	134 =	Int	

Tag	Name	Req	Valid values	Format	Description
			Adjustments rule		
			135 = Indicates if a RFQ must be generated when the cross trade can't be accepted for overcoming the LIS		
→868	EventText	N		String	<ul style="list-style-type: none"> When EventType [865] = 134, contains the adjustments rule: E = Extraordinary dividend adjustments only (T = Total DO NOT send this field on securities where adjustments don't apply When EventType [865] = 135, indicates if a RFQ must be generated when the cross trade can't be accepted for overcoming the LIS: Y = Yes N = No
End <Instrument>					
32	LastQty	N	>= 0, no decimals	Qty	Volume bought/sold in the cross trade described.
31	LastPx	N		Price	Average price in the cross trade described. If this cross trade is expressed through an effective amount, GrossTradeAmt [381], this is the rounded transaction price.
Start <TrdCapRptSideGrp>					
552	NoSides	Y	1, 2	NumInGroup	
→ 54	Side	Y	1 = Buy 2 = Sell	Char	Position that the party takes in the cross trade
Start <Parties>					
→453	NoPartyIDs	N		NumInGroup	Number of parties
→→	PartyID	N	For PartyRole	String	See section 4.3 - Parties

Tag	Name	Req	Valid values	Format	Description
448			[452] = 3, 12 or 122, this is an unsigned integer field, greater or equal than 0 and less than 2 ³²		block
→→ 447	PartyIDSource	N	D = Proprietary/ Custom code P = Short code identifier 3 = Client ID 4 = Authenticating Firm 7 = Entering Firm	Char	Required if NoPartyIDs is specified: <ul style="list-style-type: none"> Value "P" for PartyRole [452] = 3, 12 or 122 Else value "D"
→→ 452	PartyRole	N	11 = Order Origination Trader 12 = Execution within Firm ID 13 = Order Origination Firm 36 = Entering Trader 122 = Investment Decision within Firm ID	Int	Indicates the role taken by the code specified in PartyID [448]. Required if NoPartyIDs [453] is specified.
→→80 2	NoPartySubIDs	N		NumInGro up	Number of sub-identifiers. This sub-group is only present when PartyRole [452] = 11
→→→ 523	PartySubID	N		String	Phone number and contact name of the buyer/seller order origination trader
→→→ 803	PartySubIDType	N	7 = Phone number 9 = Contact name	int	

Tag	Name	Req	Valid values	Format	Description
	End <Parties>				
→ 1	Account	N		String	Account code
→ 581	AccountType	N	1 = On behalf of third parties 3 = House trader	Int	Capacity indicator (only for cash market trades)
→ 58	Text	N		String(15)	Reference
→ 232	NoStipulations	N		NumInGroup	
			CL_ID_CMT = Short code Client identification for the cash market leg		
			INV_DEC_ID_CMT = Short code to identify the party for the Investment Decision within Firm for the cash market leg		
→→ 233	StipulationType	N	INV_EXE_ID_CMT = Short code to identify the party for the Execution within Firm for the cash market leg	String	
			TR_CAP_CMT = Trading capacity for the cash market leg		
			CL_ACCT_COD_CMT = Client account code for the cash market leg		
→→ 234	StipulationValue	N		String	When StipulationType [233] = CL_ID_CMT, it contains the short code Client identification for the cash market leg. This is an unsigned integer field, greater or equal than 0 and less than 2 ³²
					When StipulationType [233] = INV_DEC_ID_CMT, it contains the short code to identify

Tag	Name	Req	Valid values	Format	Description
					the party for the Investment Decision within Firm for the cash market leg. This is an unsigned integer field, greater or equal than 0 and less than 2 ³²
					When StipulationType [233] = INV_EXE_ID_CMT, it contains the short code to identify the party for the Execution within Firm for the cash market leg. This is an unsigned integer field, greater or equal than 0 and less than 2 ³²
					When StipulationType [233] = TR_CAP_CMT, it contains the Trading capacity for the cash market leg. Los posibles valores son: <ul style="list-style-type: none"> • AOTC • MTCH • DEAL
					When StipulationType [233] = CL_ACCT_COD_CMT, it contains the Client account code for the cash market leg
	End <Stipulations>				
	Start <OrdAttrib>				
→259 3	NoOrderAttributes	N		NumInGroup	
→→25 94	OrderAttributeType	N	3 = Risk reduction order	String	<ul style="list-style-type: none"> • When OrderAttributeType [2594] = 3, indicates a Risk reduction order. Valid values: Y = In the context of ESMA RTS 22 Article 4(2)(i), when OrderAttributeValue(2595)=Y, it signifies that the commodity derivative order is a transaction "to reduce risk in an objectively measurable way in accordance with
→→25 95	OrderAttributeValue	N		String	

Tag	Name	Req	Valid values	Format	Description
					Article 57 of Directive 2014/65/EU" N = The commodity derivative order does NOT reduce risk in an objectively measurable way in accordance with Article 57 of Directive 2014/65/EU"
	End <OrdAttrib>		1 = "AOTC"		
→29	LastCapacity	N	3 = "MTCH"	Char	Trading capacity
			4 = "DEAL"		
1390	TradePublishIndicator	N	0 = Do Not Publish 1 = Publish (Default) 2 = Delta: Do Not Publish	Int	Indicates if the trade should be published or not. Not informing this tag means the trade should be published.
994	TierCode	N	R = Enviar a modalidad RFQ si es necesario N = No enviar a modalidad RFQ (default)	Char	
381	GrossTradeAmt	N		Amt	Effective amount. If informed, this value will be use instead of the price (LastPx [31]). It must be the same for the buying and selling party.
	Standard Trailer	Y			

11.11.2 Trade Capture Report (Msg Type = AE) sent by HF MEFFGate

Message containing data on a trade pending on registration and used to request the acceptance or rejection by the member

Tag	Name	Req	Valid values	Format	Description
	Standard Header	Y	MsgType = AE		
1180	ApplID	N		String	Used in conjunction with ApplSeqNum [1181] to indicate, in subsequent connections, the point from which to receive information
1181	ApplSeqNum	N		SeqNum	Used in conjunction with ApplID [1180] to indicate, in subsequent connections, the point from which to receive information
571	TradeReportID	Y		String	Contains the same value that was specified in the Trade Capture Report message sent to HF MEFFGate. On cancellation, it contains the value of the original message.
487	TradeReportTransType	N	0 = New 1 = Cancel 2 = Replace	Int	0 (New): Indicates an initial trade request 1 (Cancel): Indicates the trade request has been cancelled 2 (Replace): Indicates the trade request has been modified (i.e. because has been accepted by the member counterparty)
828	TrdType	N	See table 19 of document "Codification Tables" for details of the Trade Type codes	Int	Trade type. This value is used in conjunction with TrdSubType [829]
829	TrdSubType	N	See table 19 of document "Codification Tables" for details of the Trade Type codes	Int	This value is used in conjunction with TrdType [828]
325	UnsolicitedIndicator	N	N,Y	Boolean	Contains "Y" when the message is sent as the

Tag	Name	Req	Valid values	Format	Description
					result of a trade request
					Trade request unique identifier assigned by MEFF.
818	SecondaryTradeReportID	N		String	The Trade Capture Report messages, sent by the client application to accept or reject the trade request, must reference this information in the field SecondaryTradeReportRef ID [881]
820	TradeLinkID	N		String	Identifier sent by the MEFFGate client to associate a group of cross trades together
	Start <Instrument>				
55	Symbol	Y	Contract code	String(22)	Contract code
48	SecurityID	N	See table 21 in document "Codification Tables" for a list of possible values	String	Underlying asset
22	SecurityIDSource	N	8 = Exchange symbol	String	
167	SecurityType	N	See table 31 of document "Codification Tables" for details of the Trade Type codes	String	Product type
541	MaturityDate	N		LocalMktDate	Expiration date
202	StrikePrice	N		Price	Exercise price
231	ContractMultiplier	N		Float	Conversion factor between price units and monetary units
1193	SettlMethod	N	C = Cash settlement required P = Physical settlement required	Char	Settlement method for this security
1194	ExerciseStyle	N	0 = European 1 = American	Int	Type of exercise of this security
201	PutOrCall	N	0 = Put 1 = Call	Int	Indicates whether an option contract is a put or call
1244	FlexibleIndicator	N	Y = Flexible	Boolean	Used to indicate if this security has been defined

Tag	Name	Req	Valid values	Format	Description
			N = Standard (default)		as flexible according to "non-standard" means. When not informed, means "N = Standard "
864	NoEvents	N		NumInGroup	
→865	EventType	N	134 = Adjustments rule 135 = Indicates if a RFQ must be generated when the cross trade can't be accepted for overcoming the LIS	Int	
					<ul style="list-style-type: none"> When EventType [865] = 134, contains the adjustments rule: E = Extraordinary dividend adjustments only (T = Total
→868	EventText	N		String	DO NOT send this field on securities where adjustments don't apply <ul style="list-style-type: none"> When EventType [865] = 135, indicates if a RFQ must be generated when the cross trade can't be accepted for overcoming the LIS: Y = Yes N = No
End <Instrument>					
32	LastQty	N		Qty	Volume bought/sold in the cross trade described.
31	LastPx	N		Price	Average price in the cross trade described. If this cross trade is expressed through an effective amount, GrossTradeAmt [381], this is the rounded transaction price.
574	MatchType	N	See codification table 27	String	Describes the cross trade state
Start <TrdCapRptSideGrp>					

Tag	Name	Req	Valid values	Format	Description
552	NoSides	Y	2	NumInGroup	
→ 54	Side	Y	1 = Buy 2 = Sell	Char	Position that the party takes in the cross trade
	Start <Parties>				
→453	NoPartyIDs	N		NumInGroup	Number of parties
→→ 448	PartyID	N		String	See section 4.3 - Parties block
→→ 447	PartyIDSource	N	D = Proprietary/ Custom code P = Short code identifier 3 = Client ID 4 = Authenticating Firm 7 = Entering Firm 11 = Order Origination Trader	Char	<ul style="list-style-type: none"> Value "P" for PartyRole [452] = 3, 12 or 122 Else value "D"
→→ 452	PartyRole	N	12 = Execution within Firm ID 13 = Order Origination Firm 36 = Entering Trader 122 = Investment Decision within Firm ID	Int	
→→80 2	NoPartySubIDs	N		NumInGroup	Number of sub-identifiers. This sub-group is only present when PartyRole [452] = 11
→→→ 523	PartySubID	N		String	Phone number and contact name of the buyer/seller order origination trader
→→→ 803	PartySubIDType	N	7 = Phone number 9 = Contact	int	

Tag	Name	Req	Valid values	Format	Description
	End <Parties>		name		
→ 1	Account	N		String	Account code
→ 581	AccountType	N	1 = On behalf of third parties 3 = House trader	Int	Capacity indicator (only for cash market trades)
→ 58	Text	N		String(15)	Reference
→ 232	NoStipulations	N		NumInGroup	
			CL_ID_CMT = Short code Client identification for the cash market leg		
			INV_DEC_ID_CMT = Short code to identify the party for the Investment Decision within Firm for the cash market leg		
→→ 233	StipulationType	N	INV_EXE_ID_CMT = Short code to identify the party for the Execution within Firm for the cash market leg	String	
			TR_CAP_CMT = Trading capacity for the cash market leg		
			CL_ACCT_COD_CMT = Client account code for the cash market leg		
→→ 234	StipulationValue	N		String	When StipulationType [233] = CL_ID_CMT, it contains the short code Client identification for the cash market leg. This is an unsigned integer field, greater or equal than 0 and less than 2 ³²
					When StipulationType [233] =

Tag	Name	Req	Valid values	Format	Description
					INV_DEC_ID_CMT, it contains the short code to identify the party for the Investment Decision within Firm for the cash market leg. This is an unsigned integer field, greater or equal than 0 and less than 2 ³²
					When StipulationType [233] = INV_EXE_ID_CMT, it contains the short code to identify the party for the Execution within Firm for the cash market leg. This is an unsigned integer field, greater or equal than 0 and less than 2 ³²
					When StipulationType [233] = TR_CAP_CMT, it contains the Trading capacity for the cash market leg. Los posibles valores son: <ul style="list-style-type: none"> • AOTC • MTCH • DEAL
					When StipulationType [233] = CL_ACCT_COD_CMT, it contains the Client account code for the cash market leg
<hr/>					
	End <Stipulations>				
	Start <OrdAttrib>				
→259 3	NoOrderAttributes	N		NumInGroup	
→→25 94	OrderAttributeType	N	3 = Risk reduction order	String	
					<ul style="list-style-type: none"> • When OrderAttributeType [2594] = 3, indicates a Risk reduction order. Valid values: Y = In the context of ESMA RTS 22 Article 4(2)(i), when OrderAttributeValue(2595)=Y, it signifies that the commodity derivative order is a transaction "to reduce risk in an objectively measurable way in
→→25 95	OrderAttributeValue	N		String	

Tag	Name	Req	Valid values	Format	Description
					accordance with Article 57 of Directive 2014/65/EU"
					N = The commodity derivative order does NOT reduce risk in an objectively measurable way in accordance with Article 57 of Directive 2014/65/EU"
	End <OrdAttrib>		1 = "AOTC"		
→29	LastCapacity	N	3 = "MTCH" 4 = "DEAL"	Char	Trading capacity
	End <TrdCapRptSideGrp>				
1390	TradePublishIndicator	N	0 = Do Not Publish 1 = Publish 2 = Delta: Do Not Publish	Int	Indicates if the trade should be published or not
1011	MessageEventSource	N	C = Cross trades	String	Type of transaction
381	GrossTradeAmt	N		Amt	Effective amount. This value is use instead of the price (LastPx [31])
1328	RejectText	N	See codification table 26	String	When MatchType [574] = A, 5 or 6, identifies the reason for rejection.
	Standard Trailer	Y			

12 Request for Quote modality

12.1 Introduction

The Request for Quote modality allows HF MEFFGate clients to request private quotes to a subset of the market members and/or brokers or to all of them. Answers to the request are sent to the originator, who can choose the one or ones that better fit his interest.

12.2 Description

When a trader wishes to request quotes for a contract or a strategy in the RFQ modality the message Quote Request must be used. If necessary, before that a strategy can be created by using the message Security Definition Request (see section 8 - Strategies).

The Quote Request can be addressed to one or several members and Arranging Brokers (up to 50 destinations) or to the whole market. The requester can also be one of the destinations. The corresponding contract or strategy must be specified, together with the volume (fields Symbol [55] and OrderQty [38]). Optionally a sign and an indicative, a firm price can be included (fields Side[54], Price[44]-QuoteType[537]). Also is mandatory to indicate whether a delay in the post-trading information publication is desired or not. Since from the point of view of Regulation a RFQ has to be recorded as an order, all mandatory fields in an order must also be filled: client, decision ID, execution ID, trading capacity. An RFQ with a firm price can only have one destination member.

Quote Requests that don't result in the creation of an RFQ due to errors or any other cause will be answered with a Quote Request Reject.

Quote Requests resulting in the creation of an RFQ will be assigned by the system with a unique ID valid for the session day, in the field IOIID [23]. The system will send a couple of Quote Response messages (one for the requester and one for the destination) for each member destination included in the Quote Request. In these messages each party receives the confirmation of the relevant data of its side and the member and trader code of the counterparty (including contact information if it has been included).

Any public information related to this RFQ (to be published or not according to MiFIR pre-transparency criteria and applicable waivers) will include the same identification in the IOIID [23] of the Indication Of Interest message and the MDStreamID [1500] in the Market Data Snapshot Full Refresh message.

The destinations willing to quote, can open one or several conversations to answer one RFQ by using the message Quote Response with QuoteRespType[694] = 2 (Counter). To open a new conversation the member must fill the QuoteID [117] field with a 0, and the system will answer with a Quote Response message with the new conversation code assigned by the system (QuoteID [117]) and the field QuoteRespID with the same contents as the request. The system assigns a history number to each notification within a conversation, included in the field QuoteMsgID [1166].

The destination member must include price and volume in the opposite side to the one requested by the requester, or at least in one of them if it was undisclosed (BidPx and BidSize, or OfferPx and OfferSize).

In case the RFQ has been initiated without a firm price, the answers sent by offering trades will not be executable by the requester (nor published) until the requester sends a Quote Response message with action 4 – Make RFQ firm. In this moment all active offers will move from status “Indicative” to “Firm”. There’s a maximum time to perform this action. RFQ created with a firm price (only one destination) don’t require this action.

Once a conversation is started, both the destination member and the requester can modify their respective prices and the rest of data. To do that they can send a Quote Response message with QuoteRespType[694] = 2 (Counter), including the RFQ id (IOIID [23]), the conversation id (QuoteID [117]) and the last history number to whom they want to answer (QuoteMsgID [1166]) that must always be the last one received (in order to avoid problems with on-the-fly messages).

News regarding a conversation are notified to both parties with additional Quote Response messages.

It is not supported the modification of RFQ data outside a conversation. Therefore if any data need to be modified (greater volume) before receiving any answer, the RFQ must be cancelled and a new one must be created. In this example, if conversations have already started, the requester can also notify individually to all the partners the new volume.

The requester can cancel a RFQ by sending a Quote Response message with QuoteRespType[694] = 5 (Done Away). In this case it is not necessary to include a conversation id (QuoteID [117]) or history number (QuoteMsgID [1166]).

A RFQ can also be automatically cancelled if the maximum established time for its completion is exceeded.

RFQ in status MatchType[574] = O (Firm) can be accepted by the requester and RFQ in status MatchType[574] = N (Firm Requester) can be accepted by the destination party. A Quote Response message must be sent with QuoteRespType [694] = 1 (Hit) or 7 (End Trade, only available to the requester) and with the prices and volumes in both sides matching. The volume that will be matched will be the minimum between OrderQty and the volume in the opposite side (BidSize, OfferSize). To send QuoteRespType=7 (End Trade) has the same consequences as sending a 1 (Hit) and then a 5 (Done Away).

Once accepted the RFQ, in case any of the parties (requester and/or quoting party) is an Arranging Broker, the system will send Trade Capture Report messages (see chapter 0) to the intermediated members in order to obtain their corresponding validation.

When the RFQ is finally registered, MatchType[574] = 9, both the requester and the destination member receive the corresponding Execution Report messages (ExecType = F, Trade). The CrossID [548] field of the Execution Report message contains the QuoteID [117] (Conversation ID) value assigned by the quoting party.

All RFQ are cancelled at end of session.

12.3 Message list

Message	Description
Quote Request (Msg Type = R)	Message sent by the HF MEFFGate client to request a quote
Quote Response sent by HF MEFFGate (RFQ status) (Msg Type = AJ)	Message sent by HF MEFFGate to notify the RFQ situation (both to requester and destinations)
Quote Response sent to HF MEFFGate (Msg Type = AJ)	Message sent by the HF MEFFGate client to answer a Quote Response (both requester and destinations)
Business Message Reject (MsgType = j)	Message sent by HF MEFFGate to reject a Quote Response
Quote Request Reject rejecting a Quote Request (Msg Type = AG)	Message sent by HF MEFFGate to reject a Quote Request

Request for Quote to two members, one of them answers, and requester accepts

The requester (A008) sends a Request for Quote for 100 A contracts to two members (A007 and A009). The system announces the request with status M (indicative) with two Quote Response messages to each member couple (requester-destination). The requester member A008 receives as many Quote Response messages as destination members.

The destination member A007 sends a buying offer with price 333.33. The offer is confirmed to A007 and announced to A008.

The requester send a Quote Response message with QuoteRespType [694] = "4" (Make RFQ firm). In this moment all active offers will move from status from "Indicative" to "Firm". There is a limited period of time to carry out this action.

The system checks the nominal amount of the order response in order to be published or not according to MiFIR pre-transparency criteria and applicable waivers.

The requester A008 accepts including his side (2=Sell), his price (the same as the quoted price) and QuoteRespType=7 (End Trade). Members A007 and A008 receive the confirmation of the acceptance (also with the corresponding Execution Report messages) and members A009 and A008 receive the cancellation of their conversation.

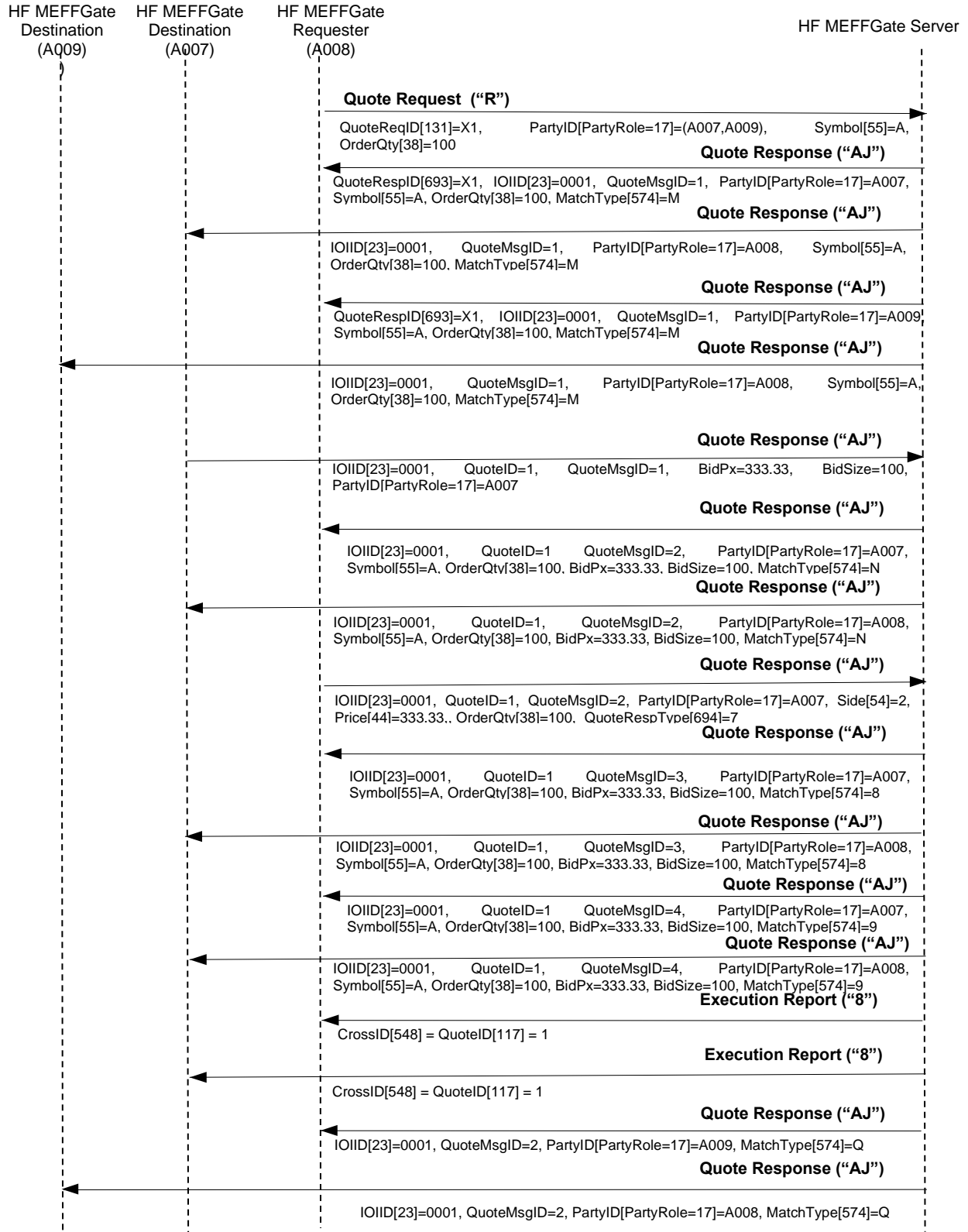

Request for Quote rejected by HF MEFFGate

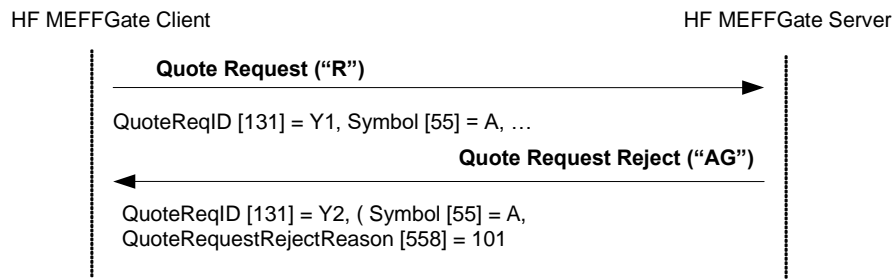

12.5 Annotations and adaptations of FIX 5.0

- In message Quote Request, field OrderQty [38] is required
- In message Quote Response sent to HF MEFFGate, fields IOIID [23] and StipulationValue [234] when StipulationType [233] = SIDE_ID are required
- In messages Quote Request, Quote Response sent by HF MEFFGate (RFQ status) and Quote Response sent to HF MEFFGate, the field LastCapacity [29] and the component block OrdAttrib are added.
- In messages Quote Request and Quote Response sent by HF MEFFGate (RFQ status), the fields TradePublishIndicator [1390] is added
- In message Quote Response sent by HF MEFFGate (RFQ status), the fields MatchType [574] and RejectText [1328] are added
- In messages Quote Response sent by HF MEFFGate (RFQ status) and Quote Request Reject rejecting a Quote Request the fields ApplID [1180] and ApplSeqNum [1181] are added

12.6 Message definition

12.6.1 Quote Request (Msg Type = R)

Message sent by the HF MEFFGate client to request quotes to a subset of market participants or to all market.

Tag	Name	Req	Valid values	Format	Description
	Standard Header	Y	MsgType = R		
131	QuoteReqID	Y		String (10)	Message identifier
	Start <RootParties>				
1116	NoRootPartyIDs	Y		NumInGroup	
→1117	RootPartyID	N	For RootPartyRole [1119] = 3, 12 or 122, this is an unsigned integer field, greater or equal than 0 and less than 2 ³²	String	See section 4.3 - Parties block
→1118	RootPartyIDSource	N	D = Proprietary/ Custom code P = Short code identifier	Char	Required if NoPartyIDs is specified: <ul style="list-style-type: none"> Value "P" for RootPartyRole [1119] = 3, 12 or 122 Value "D" for the rest
			3 = Client ID		Indicates the role taken by the code specified in RootPartyID [1117].
			4 = Authenticating Firm		
			7 = Entering Firm		Required if NoRootPartyIDs [1116] is specified.
			12 = Execution within Firm ID		
→1119	RootPartyRole	N	13 = Order Origination Firm 17 = Contra Firm 36 = Entering Trader 122 = Investment Decision within Firm ID	Int	Value 17 indicates that the contents in RootPartyID[1117] are the member-traders destination of the RFQ. If party 17 is not included the request goes to all market participants. A maximum of 50 explicit contras can be specified
					See section 4.3 - Parties block for all the other parties
	Start <RootSubParties>				
→1120	NoRootPartySubIDs	N		NumInGroup	Number of sub-identifiers. This sub-group is only present when RootPartyRole [1119] = 36

Tag	Name	Req	Valid values	Format	Description
→→1121	RootPartySubID	N		String	Phone number and contact name of the buyer/seller order origination trader
			7 = Phone number		
→→1122	RootPartySubIDType	N	9 = Contact name	int	
	End <RootSubParties>				
	End <RootParties>				
	Start <QuotReqGrp>				
146	NoRelatedSym	Y	1	NumInGroup	Only one instrument. For strategies, please create a strategy before using RFQ with a Security Definition Request
	Start <Instrument>				
→55	Symbol	Y	Contract code	String (22)	
	End <Instrument>				
→537	QuoteType	N	0 = Indicative (default) 1 = Tradeable 1 = Buy	Int	Use 1 in firm quote requests sent to only one party
			2 = Sell		
→54	Side	N	7 = Undisclosed (default in indicative quotes)	Char	
	Start <OrderQtyData>				
→38	OrderQty	Y*	integer numbers only	Qty	Volume requested
	End <OrderQtyData>				
	Start <Stipulations>				
→ 232	NoStipulations	N		NumInGroup	
			REF_RFQ = Reference		
			CL_ID_CMT = Short code Client identification for the cash market leg		
→→ 233	StipulationType	N	INV_DEC_ID_CM T = Short code to identify the party for the Investment Decision within Firm for the cash	String	

Tag	Name	Req	Valid values	Format	Description
			market leg		
			INV_EXE_ID_CMT = Short code to identify the party for the Execution within Firm for the cash market leg		
			TR_CAP_CMT = Trading capacity for the cash market leg		
			CL_ACCT_COD_C MT = Client account code for the cash market leg		
					When StipulationType [233] = REF_RFQ, it contains the reference. This is a string field up to 15 characters
					When StipulationType [233] = CL_ID_CMT, it contains the short code Client identification for the cash market leg. This is an unsigned integer field, greater or equal than 0 and less than 2 ³²
→→ 234	StipulationValue	N		String	When StipulationType [233] = INV_DEC_ID_CMT, it contains the short code to identify the party for the Investment Decision within Firm for the cash market leg. This is an unsigned integer field, greater or equal than 0 and less than 2 ³²
					When StipulationType [233] = INV_EXE_ID_CMT, it contains the short code to identify the party for the Execution within Firm for the cash market leg. This is an unsigned integer field, greater or equal than 0 and less than 2 ³²
					When StipulationType [233] = TR_CAP_CMT, it contains the

Tag	Name	Req	Valid values	Format	Description
					Trading capacity for the cash market leg. Los posibles valores son: <ul style="list-style-type: none"> AOTC MTCH DEAL
					When StipulationType [233] = CL_ACCT_COD_CMT, it contains the Client account code for the cash market leg
End <Stipulations>					
→ 1	Account	N		String	Account code
→44	Price	N		Price	Firm or indicative price depending on QuoteType [537]
Start <OrdAttrib>					
→2593*	NoOrderAttributes	N		NumInGroup	
→→2594*	OrderAttributeType	N	3 = Risk reduction order	String	<ul style="list-style-type: none"> When OrderAttributeType [2594] = 3, indicates a Risk reduction order. Valid values: <ul style="list-style-type: none"> Y = In the context of ESMA RTS 22 Article 4(2)(i), when OrderAttributeValue(2595)=Y, it signifies that the commodity derivative order is a transaction "to reduce risk in an objectively measurable way in accordance with Article 57 of Directive 2014/65/EU" N = The commodity derivative order does NOT reduce risk in an objectively measurable way in accordance with Article 57 of Directive 2014/65/EU"
→→2595*	OrderAttributeValue	N		String	
End <OrdAttrib>					
			1 = "AOTC"		
→29*	LastCapacity	N	3 = "MTCH" 4 = "DEAL"	char	Trading Capacity MiFIR
End <QuotReqGrp>					
1390*	TradePublishIndicator	N	0 = Do Not Publish 1 = Publish (Default)	Int	Indicates if the trade should be published or not. Not informing this tag means the trade should be published.

Tag	Name	Req	Valid values	Format	Description
			2 = Delta: Do Not Publish		
	Standard Trailer	Y			

12.6.2 Quote Response sent by HF MEFFGate (RFQ status) (Msg Type = AJ)

Message sent by HF MEFFGate to communicate to requester and destination the status of a RFQ.

Tag	Name	Req	Valid values	Format	Description
	Standard Header	Y	MsgType = AJ		
1180*	ApplID	N		String	Used in conjunction with ApplSeqNum [1181] to indicate, in subsequent connections, the point from which to receive information
1181*	ApplSeqNum	N		SeqNum	Used in conjunction with ApplID [1180] to indicate, in subsequent connections, the point from which to receive information Message identifier.
693	QuoteRespID	Y		String	The answer to the party that triggers a message will receive here the corresponding QuoteReqID [131] or QuoteRespID [693]. For the rest of parties it contains "NONE".
117	QuoteID	N		String	Conversation ID entered by the quoting party (unique for each IOIID and counterparty). Field not sent while no offers are made.
1166	QuoteMsgID	N		String	History number within a conversation
694	QuoteRespType	Y	0	Int	This field should not be considered, and is included as requirement of the standard
23	IOIID	N		String	RFQ identifier as assigned by the system
537	QuoteType	N	0 = Indicative 1 = Tradeable	Int	
574*	MatchType	N	See codification table 35	String	
	Start <Parties>				
453	NoPartyIDs	N		NumInGroup	
→448	PartyID	N		String	See section 4.3 - Parties block
→447	PartyIDSource	N	D = Proprietary/ Custom code P = Short code identifier	Char	<ul style="list-style-type: none"> Value "P" for PartyRole [452] = 3, 12 or 122 Value "D" for the rest
→452	PartyRole	N	3 = Client ID 4 = Authenticating	Int	Indicates the role taken by the code specified in PartyID [448].

Tag	Name	Req	Valid values	Format	Description
			Firm		Only one party 17 and one 37 will be received in each message
			7 = Entering Firm		
			11 = Order Origination Trader		
			12 = Execution within Firm ID		
			13 = Order Origination Firm		
			17 = Contra Firm		
			36 = Entering Trader		
			37 = Contra Trader		
			122 = Investment Decision within Firm ID		
Start <SubParties>					
→802	NoPartySubIDs	N		NumInGroup	Number of sub-identifiers. This sub-group is only present when PartyRole [452] = 36
→→523	PartySubID	N		String	Phone number and contact name of the buyer/seller order origination trader
→→803	PartySubIDType	N	7 = Phone number 9 = Contact name	int	
End <SubParties>					
End <Parties>					
Start <Instrument>					
55	Symbol	Y	Contract code	String (22)	
48	SecurityID	N		String(12)	ISIN security code
22	SecurityIDSource	N	4 = ISIN Number	String	
End <Instrument>					
			1 = Buy		
			2 = Sell		
54	Side	N	7=Undisclosed (default in public quotes públicos or indicatives)	Char	Requester side
Start <OrderQtyData>					
38	OrderQty	N		Qty	Volume requested Will be 0 in cancellations
End <OrderQtyData>					
Start <Stipulations>					
232	NoStipulations	N		NumInGroup	

Tag	Name	Req	Valid values	Format	Description
			SIDE_ID		
			RTS24_21		
			RTS24_21_BUY		
			RTS24_21_SELL		
			CL_ID_CMT = Short code Client identification for the cash market leg		
			REF_RFQ = Reference		
			INV_DEC_ID_CMT = Short code to identify the party for the Investment Decision within Firm for the cash market leg		"RTS24_21" is for the requester and destination
→233	StipulationType	N	INV_EXE_ID_CMT = Short code to identify the party for the Execution within Firm for the cash market leg	String	"RTS24_21_BUY" and "RTS24_21_SELL" are for destination
			TR_CAP_CMT = Trading capacity for the cash market leg		
			CL_ACCT_COD_CMT = Client account code for the cash market leg		
					<ul style="list-style-type: none"> When StipulationType [233] = "SIDE_ID" the possible values are: <ul style="list-style-type: none"> I = Message addressed to the Requester D = Message addressed to the Destination
→234	StipulationValue	N		String	<ul style="list-style-type: none"> When StipulationType [233] = "RTS24_21", "RTS24_21_BUY" or "RTS24_21_SELL", according to RTS 24, the valid values are: <ul style="list-style-type: none"> NEWO = New order NECP = New order of the counterparty REME = Replaced by initiative of message

Tag	Name	Req	Valid values	Format	Description
					<ul style="list-style-type: none"> receiver ○ REMA = Replaced by Market Surveillance (automatic) ○ REMH = Replaced by Market Surveillance (manual) ○ RECP = Replaced due to change in the counterparty order ○ CAME = Cancellation by initiative of message receiver ○ CAMO = Cancellation by Surveillance ○ CACP = Cancellation by counterparty ○ REMO = Rejection ○ EXPI = Order expired ○ PARF = Partial fill ○ FILL = Filled ○ CHME = Change of status at the initiative of the member/participant of the trading venue ○ CHMO = Change of status due to market operations <ul style="list-style-type: none"> • When StipulationType [233] = REF_RFQ, it contains the reference • When StipulationType [233] = CL_ID_CMT, it contains the short code Client identification for the cash market leg. This is an unsigned integer field, greater or equal than 0 and less than 232 • When StipulationType [233] = INV_DEC_ID_CMT, it contains the short code to identify the party for the Investment Decision within Firm for the cash market leg. This is an unsigned integer field, greater or equal than 0 and less than 232 • When StipulationType [233] = INV_EXE_ID_CMT, it contains the short code to identify the party for the Execution within Firm for the cash market leg. This is an unsigned integer field,

Tag	Name	Req	Valid values	Format	Description
					greater or equal than 0 and less than 232
					<ul style="list-style-type: none"> When StipulationType [233] = TR_CAP_CMT , it contains the Trading capacity for the cash market leg. Los posibles valores son: <ul style="list-style-type: none"> AOTC MTCH DEAL When StipulationType [233] = CL_ACCT_COD_CMT, it contains the Client account code for the cash market leg
	End <Stipulations>				
1	Account	N		String(5)	Account code
	Start <OrdAttrib>				
2593*	NoOrderAttributes	N		NumInGroup	
→2594*	OrderAttributeType	N	3 = Risk reduction order	String	
					<ul style="list-style-type: none"> When OrderAttributeType [2594] = 3, indicates a Risk reduction order. Valid values: Y = In the context of ESMA RTS 22 Article 4(2)(i), when OrderAttributeValue(2595)=Y, it signifies that the commodity derivative order is a transaction "to reduce risk in an objectively measurable way in accordance with Article 57 of Directive 2014/65/EU" N = The commodity derivative order does NOT reduce risk in an objectively measurable way in accordance with Article 57 of Directive 2014/65/EU"
→2595*	OrderAttributeValue	N		String	
	End <OrdAttrib>				
			1 = "AOTC"		
29*	LastCapacity	N	3 = "MTCH" 4 = "DEAL"	Char	Trading Capacity MiFIR
132	BidPx	N		Price	Firm buy price of the quoting party
133	OfferPx	N		Price	Firm sell price of the quoting party

Tag	Name	Req	Valid values	Format	Description
134	BidSize	N		Qty	Firm buy volume of the quoting party
135	OfferSize	N		Qty	Firm sell volume of the quoting party
60	TransactTime	N		UTC Timestamp	Timestamp when the business transaction represented by the message occurred
44	Price	N			Requester Price
1328*	RejectText	N		String	When MatchType [574] = B contains further information about reject reason
			0 = Do Not Publish		
1390*	TradePublishIndicator	N	1 = Publish (Default) 2 = Delta: Do Not Publish	Int	Indicates if the trade should be published or not. Not informing this tag means the trade should be published.
	Standard Trailer	Y			

12.6.3 Quote Response sent to HF MEFFGate (Msg Type = AJ)

Message sent by a HF MEFFGate client to answer or modify a RFQ.

Tag	Name	Req	Valid values	Format	Description
	Standard Header	Y	MsgType = AJ		
693	QuoteRespID	Y		String (10)	Message identifier
117	QuoteID	N	Unsigned integer field, greater than 0 and less than 2 ³¹	String	Conversation ID entered by the quoting party (unique for each IOIID and counterparty). Mandatory except if QuoteRespType[694]=5
1166	QuoteMsgID	N		String	History number within a conversation to which this Quote Response refers. It avoids problems with on-the-fly messages. Mandatory except when QuoteRespType[694] is 5 or 6
694	QuoteRespType	Y	1 = Hit 2 = Counter 4 = Make RFQ firm 5 = Done Away 6 = Pass 7 = End Trade	Int	Value 1 to accept one offer and keep the rest Value 2 to make a counter offer Value 4 to make executable the received offers and publish (requester) Value 5 to cancel all remaining RFQ conversations (requester) Value 6 to decline (destination)/cancel (requester) a conversation Value 7 to accept one offer and cancel the rest (requester)
23	IOIID	Y*		String	RFQ identifier as assigned by the system
537	QuoteType	N	0 = Indicative (default) 1 = Tradeable	Int	Ignored for messages not entered by the requester
453	NoPartyIDs	N		NumInGroup	
→448	PartyID	N	For RootPartyRole [1119] = 3, 12 or 122, this is an unsigned integer field, greater or equal than 0 and less than 2 ³²	String	See section 4.3 - Parties block

Tag	Name	Req	Valid values	Format	Description
→447	PartyIDSource	N	D = Proprietary/ Custom code P = Short code identifier	Char	Required if NoPartyIDs is specified: <ul style="list-style-type: none"> Value "P" for PartyRole [452] = 3, 12 or 122 Value "D" for the rest
→452	PartyRole	N	See codification table 35	Int	Indicates the role taken by the code specified in PartyID [448]. Required if NoPartyIDs [453] is specified. Only one party 17 and one 37 will be received in each message
Start <SubParties>					
→802	NoPartySubIDs	N		NumInGroup	Number of sub-identifiers. This sub-group is only present when PartyRole [452] = 36
→→523	PartySubID	N		String	Phone number and contact name of the buyer/seller order origination trader
→→803	PartySubIDType	N	7 = Phone number 9 = Contact name	int	
End <SubParties>					
End <Parties>					
Start <Instrument>		Y			
55	Symbol	Y		String (22)	Contract code
48	SecurityID	N		String(12)	ISIN security code
22	SecurityIDSource	N	4 = ISIN Number	String	
End <Instrument>					
54	Side	N	1 = Buy 2 = Sell 7 = Undisclosed	Char	The requester must indicate 1 or 2 when entering a firm Price (Counter) or accepting an offer (Hit, End Trade). Ignored in any other case
Start <OrderQtyData>					
38	OrderQty	N	Integer numbers only	Qty	Mandatory for the requester when entering a firm Price (Counter) or accepting an offer (Hit, End Trade)
End <OrderQtyData>					
Start <Stipulations>					
232	NoStipulations	Y*		NumInGroup	
→ 233	StipulationType	Y*	SIDE_ID (required) REF_RFQ = Reference	String	

Tag	Name	Req	Valid values	Format	Description
			CL_ID_CMT = Short code Client identification for the cash market leg		
			INV_DEC_ID_CM T = Short code to identify the party for the Investment Decision within Firm for the cash market leg		
			INV_EXE_ID_CMT = Short code to identify the party for the Execution within Firm for the cash market leg		
			TR_CAP_CMT = Trading capacity for the cash market leg		
			CL_ACCT_COD_C MT = Client account code for the cash market leg		
→ 234	StipulationValue	Y*		String	<ul style="list-style-type: none"> When StipulationType [233] = "SIDE_ID" (required) the possible values are: <ul style="list-style-type: none"> I = Message sent by the Requester D = Message sent by the Destination When StipulationType [233] = REF_RFQ, it contains the reference. This is a string field up to 15 characters When StipulationType [233] = CL_ID_CMT, it contains the short code Client

Tag	Name	Req	Valid values	Format	Description
					<p>identification for the cash market leg. This is an unsigned integer field, greater or equal than 0 and less than 2^{32}</p> <ul style="list-style-type: none"> When StipulationType [233] = INV_DEC_ID_CMT, it contains the short code to identify the party for the Investment Decision within Firm for the cash market leg. This is an unsigned integer field, greater or equal than 0 and less than 2^{32} When StipulationType [233] = INV_EXE_ID_CMT, it contains the short code to identify the party for the Execution within Firm for the cash market leg. This is an unsigned integer field, greater or equal than 0 and less than 2^{32} When StipulationType [233] = TR_CAP_CMT, it contains the Trading capacity for the cash market leg. Los posibles valores son: <ul style="list-style-type: none"> AOTC MTCH DEAL <p>When StipulationType [233] = CL_ACCT_COD_CMT, it contains the Client account code for the cash market leg</p>
	End <Stipulations>				
1	Account	N		String(5)	Account code
	Start <OrdAttrib>				
2593*	NoOrderAttributes	N		NumInGroup	
→2594*	OrderAttributeType	N	3 = Risk reduction order	String	
→2595*	OrderAttributeValue	N		String	<ul style="list-style-type: none"> When OrderAttributeType [2594] = 3, indicates a Risk reduction order. Valid values: Y = In the context of ESMA RTS 22 Article 4(2)(i), when OrderAttributeValue(2595)=Y, it signifies that the

Tag	Name	Req	Valid values	Format	Description
					commodity derivative order is a transaction "to reduce risk in an objectively measurable way in accordance with Article 57 of Directive 2014/65/EU" N = The commodity derivative order does NOT reduce risk in an objectively measurable way in accordance with Article 57 of Directive 2014/65/EU"
	End <OrdAttrib>		1 = "AOTC"		
29*	LastCapacity	N	3 = "MTCH" 4 = "DEAL"	char	Trading Capacity MiFIR
132	BidPx	N		Price	Firm buy price of the quoting party
133	OfferPx	N		Price	Firm sell price of the quoting party
134	BidSize	N		Qty	Firm buy volume of the quoting party
135	OfferSize	N		Qty	Firm sell volume of the quoting party
44	Price	N		Price	Indicative or firm Price of the requester. Mandatory for the requester when entering a firm Price (Counter) or accepting an offer (Hit, End Trade). Ignored in any other case
	Standard Trailer	Y			

12.6.4 Quote Request Reject rejecting a Quote Request (Msg Type = AG)

Message sent by HF MEFFGate to reject a Quote Request

Tag	Name	Req	Valid values	Format	Description
	Standard Header	Y	MsgType = AG		
1180 *	ApplID	N		String	Used in conjunction with ApplSeqNum [1181] to indicate, in subsequent connections, the point from which to receive information
1181 *	ApplSeqNum	N		SeqNum	Used in conjunction with ApplID [1180] to indicate, in subsequent connections, the point from which to receive information
131	QuoteReqID	Y		String	Identifier of the rejected message
658	QuoteRequestRejectReason	Y	See codification table 34	Int	Rejection motive
	Start <QuotReqRjctGrp>				
146	NoRelatedSym	Y	1	NumInGroup	Always 1
	Start <Instrument>				
→55	Symbol	Y		String (22)	Contract code
→48	SecurityID	N		String(12)	ISIN security code
→22	SecurityIDSource	N	4 = ISIN Number	String	
	End <Instrument>				
	End <QuotReqRjctGrp>				
	Standard Trailer	Y			

13 Communication of Events

13.1 Introduction

This chapter describes two functionalities based on the News message:

- Relay information from the market supervisor to one or more traders
- Send messages of a trader to the market supervisor

In both cases the information transferred has a free text format.

A client program does not need to subscribe to receive these messages. Every client is implicitly subscribed from the start of the session.

On establishing a communications connection, if the client continues the FIX session he will receive all the pending News messages from the time of disconnection. When the client opts to begin a new FIX session, he receives all the News messages addressed to him that have been generated from the start of the session.

13.2 List of messages

Message	Description
News (Msg Type = B)	Used to receive text messages from the market supervisor. Also used to send text messages to the market supervisor

13.3 Message flow

Message reception



Sending message



13.4 Annotations and adaptations of FIX 5.0

- Only one line of up to 78 characters per message is allowed

13.5 Definition of messages

13.5.1 News (Msg Type = B)

Tag	Name	Req	Valid values	Format	Description
	<i>Standard Header</i>	Y	MsgType = B		
1180	ApplID	N		String	Used in conjunction with ApplSeqNum [1181] to indicate, in subsequent connections, the point from which to receive information
1181	ApplSeqNum	N		SeqNum	Used in conjunction with ApplID [1180] to indicate, in subsequent connections, the point from which to receive information
42	OrigTime	N		UTCTimeStamp	Event time
			0 = Normal		
61	Urgency	N	1 = Flash 2 = Background	Char	The default value is 0
148	Headline	Y		String	Message header. Ignored by HF MEFFGate
33	LinesOfText	Y	1	NumInGroup	Number of lines of text. Only one line allowed
→58	Text	Y		String(78)	One line of text
	<i>Standard Trailer</i>	Y			

MEFF Order Types

The following table sets out the different order types on MEFF with the FIX OrdType [40] and TimeInForce [59] fields:

MEFF Order Type	OrdType [40]	TimeInForce [59]	Allows instructions for automatic cancellation in the event of a disconnection
Limit order	Limit (2)	Day (0) GTD (6)	YES NO
Immediate limit order	Limit (2)	IOC (3)	N/A
Market order	Market (1)	Day (0)	YES
Stop limit order	Stop Limit (4)	Day (0) GTD (6)	YES NO
Fill or kill order	Limit (2)	FOK (4)	N/A
Auction price order	Market (1)	At Opening (2)	YES

Triggering Instructions for Stop limit orders. If component block <TriggeringInstruction> is not specified when the order is sent, then the Stop limit order is triggered at Last Trade:

BME Order Type	TriggerType [1100]	TriggerPriceType [1107]
Stop limit order	4 = Price Movement	1 = Best Offer 2 = Last Trade 3 = Best Bid 4 = Best Bid or Last Trade 5 = Best Offer or Last Trade 6 = Best Mid Bid-Offer

User Fields

The following table shows the user fields that are found in the messages of this manual

Tag	Name	Format	Description
5678	ReceivePendings	Boolean	Indicates whether the receipt of Execution Reports pending confirmation is required or not
21501	LocalMktTimestamp	String	Indicates, for all tags in which a timestamp is included, the timestamp format: Y - HF MEFFGate will send the local market time (all messages up to microseconds) N - HF MEFFGate will send the the time in UTC format according to the FIX standard (all messages up to microseconds) For more information see "4.6 - Timestamp format" Subscriptions identifier.
21502	AutoSubscriptionsID	String (10)	If this tag is informed, a subscription to Trading Session Status Request Security List Request, Market Data Request (+Indication of Interest) is implied. Otherwise the classical behaviour is assumed. For more information see "4.7 - Implied subscription to Trading Session Status Request, Security List Request and Market Data Request"
21503	ExecutionsOnly	Boolean	Indicates the user wants to receive trades only. Possible values are: Y - Only Execution Report messages with ExecType [150] = F (Trade) are received. Also Quote Status Report messages will never be received N (default) - Classical behaviour
21504	MaxMsgPerSecond	Int	Maximum number of messages per second that can be sent, as contracted for the client. If the number of messages sent by the client application per second exceeds the number indicated, the client application could experience delays in processing the messages.
21505	BusinessSessionDate	LocalMkt Date	Current business session date.

This material has been prepared by Bolsas y Mercados Españoles, Sociedad Holding de Mercados y Sistemas Financieros S. A. (BME), its subsidiaries, affiliates and/or their branches (together, "BME") for the exclusive use of the persons to whom BME delivers this material. This material or any of its content is not to be construed as a binding agreement, recommendation, investment advice, solicitation, invitation or offer to buy or sell financial information, products, solutions or services. The information does not reflect the firm positions (proprietary or third party) of the entities involved in the Spanish Securities Market. BME is under no obligation to update, revise or keep current the content of this material, and is subject to change without notice at any time. No representation, warranty, guarantee or undertaking – express or implied – is or will be given by BME as to the accuracy, completeness, sufficiency, suitability or reliability of the content of this material.

The opinions presented are theoretical and, therefore, the content hereof is intended for informational purposes only and should not be used for portfolio or asset valuations, or as the basis for any investment recommendations. Neither contributing Entities, nor Bolsas y Mercados Españoles, Sociedad Holding de Mercados y Sistemas Financieros S.A.(BME) nor any of its subsidiaries, accept responsibility for any financial loss or decision made based on the information contained in this material. In general, neither Bolsas y Mercados Españoles, Sociedad Holding de Mercados y Sistemas Financieros S. A. (BME) nor any of its subsidiaries, nor the contributing Entities, their directors, representatives, associates, subsidiaries, managers, partners, employees or advisors accept any responsibility for this information or unauthorised use of the same.

This material is property of BME and may not be printed, copied, reproduced, published, passed on, disclosed or distributed in any form without the express prior written consent of BME.

2023 Bolsas y Mercados Españoles, Sociedad Holding de Mercados y Sistemas Financieros S. A. All rights reserved.

BME
Plaza de la Lealtad,1
Palacio de la Bolsa
28014 Madrid

www.bolsasymercados.es

